

db

THE SOUND ENGINEERING MAGAZINE

MARCH 1969 75c

Improved Studio Monitoring

An Eight-Foot Board

The Design of a Sequencer

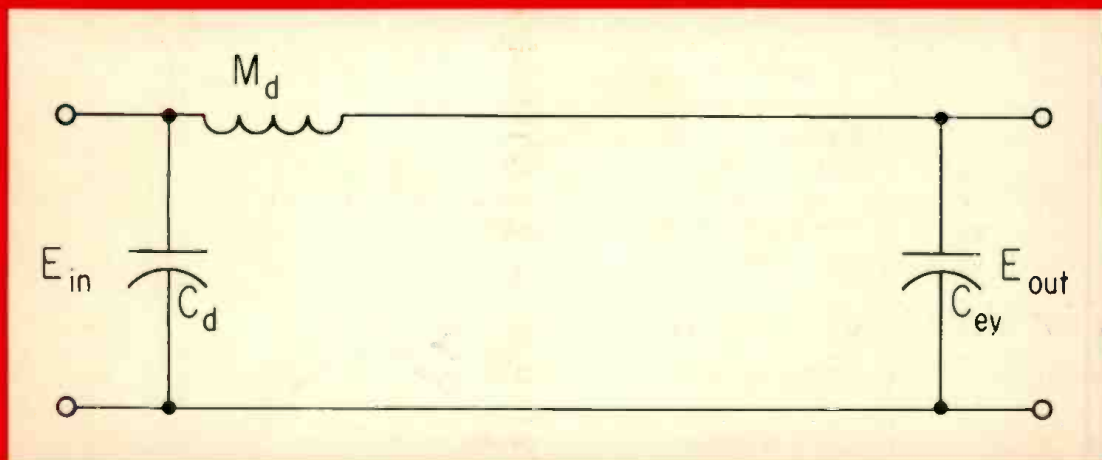



THE NEWEST STAR ON THE RECORDING HORIZON...

"The Customized Console"

W. A. L. now offers a complete line of factory-wired mixing console systems for the advanced, multi-track recording studio. Just plug in audio connectors to rear panel of our console and your studio is on the road to higher profits with no "down time." Our system includes every function necessary for the most advanced studio operation, except microphones, speakers, and tape recorders.

Our pre-wired console cabinet defies obsolescence by allowing a small studio to start with an 8 input 4 track system and expand it up to 22 inputs and 8, 12, or 16 output tracks. All our front panel mounted modules plug in or out to allow additions or subtractions to the system at the customer's convenience. All circuit functions are incorporated within the plug-in modules, thus eliminating "loose end," under the cabinet, mounted circuits, found in other leading console systems.

Most W. A. L. systems include a separate 4, 8, 12, or 16 position remix section for continuous sample mixes during actual recording. This remix section employs the same multi-function Input/Remix module as the input section of the console, not just a little line level mixer, off to one side of the control surface. Our production type manufacturing techniques make it possible to give this system flexibility at no extra cost.

Consider these innovations...

- **Built in** —REVERB BESIDES EXTERNAL ECHO
- **Built in** —120 WATT PLAYBACK AMPLIFIERS
- **Built in** —SLATING, TALK BACK, & CUEING CIRCUITS
- **Built in** —SYNC-MASTER & DIRECTIONAL REMOTE CONTROLS
- **Built in** —SPECIAL EFFECTS SWITCHING & GRAPHIC EQ.

For further information, write or call:

WIEGAND *Audio* LABORATORIES

3402 WINDSOR ROAD • WALL, NEW JERSEY 07719
PHONE: (201) 681-6443

DISTRIBUTORS OF SCULLY TAPE RECORDERS

Circle 10 on Reader Service Card



MODEL 100
INPUT/
REMIX
MODULE

MODEL 300
MASTER
RECORD/
REVERB
MODULE

MODEL 212
12 POS.
OUTPUT
SWITCH
MODULE

Coming Next Month

• Test Records is the title of a major article by Arnold Schwartz. The test record remains a primary tool in the audio industry. However, the practical uses and limitations are not always clearly understood. The article stresses these values using as examples the most commonly available and seriously considered test records directed toward professional audio use.

A short-circuit protected power supply for audio amplifiers is the topic of a paper by Walter Jung and Richard Groom. They describe a practical power supply that is electronically regulated and has circuit breaker protection.

Next month we will have complete details on the papers and exhibits to be seen at the AES Convention to be held in Hollywood at the end of April.

And there will be our regular columnists, George Alexandrovich, Norman H. Crowhurst, Arnold Schwartz, and Martin Dickstein. Coming in *db*, The Sound Engineering Magazine.

About the Cover

• The circuit pictured is a simplified equivalency for a headphone. M_d = mass of the diaphragm; C_d = compliance of the diaphragm; C_{ev} = compliance of the ear volume. See Howard Souther's article beginning on page 17.

db

THE SOUND ENGINEERING MAGAZINE

MARCH 1969 • Volume 3, Number 3

Table of Contents

FEATURE ARTICLES

- Improved Monitoring With Headphones
Howard T. Souther 17
- An Eight-Foot Board
Charles E. Wiegand, Jr. 22
- An Electronic Music Sequencer
Robert C. Ehle 26

MONTHLY DEPARTMENTS

- Letters 2
- The Audio Engineer's Handbook
George Alexandrovich 4
- The Feedback Loop
Arnold Schwartz 10
- Sound With Images
Martin Dickstein 12
- Editorial 16
- Theory and Practice
Norman H. Crowhurst 29
- The *db* Bookcase 30
- Classified 31
- People, Places, Happenings 32

EDITORIAL BOARD OF REVIEW

George Alexandrovich
Sherman Fairchild
Norman Anderson
Prof. Latif Jiji
Daniel R. von Recklinghausen
William L. Robinson
Paul Weathers
John H. McConnell

db, the Sound Engineering Magazine is published monthly by Sagamore Publishing Company, Inc. Entire contents copyright © 1969 by Sagamore Publishing Co., Inc., 980 Old Country Road, Plainview, L.I., N.Y. 11803. Telephone (516) 433-6530. *db* is distributed to qualified individuals and firms in professional audio—recording, broadcast, audio-visual, sound reinforcement, consultants, video recording, film sound, etc. Application must be made on an official subscription form or on a company letterhead. Subscriptions are \$6.00 per year (\$7.00 per year outside U. S. Possessions, Canada, and Mexico) in U. S. funds. Single copies are 75c each. Controlled Circulation postage paid at Easton, Pa. 18042. Editorial, Publishing, and Sales Offices: 980 Old Country Road, Plainview New York 11803. Postmaster: Form 3579 should be sent to above address.

One of a series of brief discussions
by Electro-Voice engineers



Much has recently been written about the sonic problems of typical auditoriums and the affect of poor room acoustics on sound system design. In an effort to better understand the extent of this problem, a series of laboratory tests of room response was conducted in a variety of community and university auditoriums.

Using a "pink noise" generator and a 1/10-octave band pass filter, plus calibrated transducers, each auditorium was curved from 20 to 20,000 Hz (obtaining usable information from 60 to 18,000 Hz). Composite or average curves were computed from 30 separate locations in each room. These curves were remarkably similar and distinguished by a lack of sharp peaks and dips. In short, the rooms studied were relatively flat, with no pronounced deviations in response.

Techniques for narrow-band filtering to compensate for both room and sound system response variations have gained prominence lately, and for good reason. In many installations such methods provide markedly higher gain before feedback, permitting installation of a successful system in environments that would otherwise be notably deficient.

But such elaborations are expensive and complex, demanding considerable experience and knowledge to install correctly. Our studies have convinced us that the use of truly flat transducers can achieve virtually equal results in the majority of auditoriums at greatly reduced cost while retaining simplicity and reliability.

Unfortunately, many highly-regarded sound reinforcement transducers are far from flat, and may themselves introduce serious flaws in system response. Faulty placement of speakers can also create response problems and hinder good coverage. The addition of narrow-band filtering to such a system may achieve the desired final result, but at the expense of greatly increased cost compared to flat, unfiltered, peak-free components.

In any event, if flat response is the desired goal, it seems logical to begin with flat transducers, adding filtering only as needed to complement the characteristics of the room. Experimental results so far confirm the value of this approach in terms of both audible performance and ultimate cost.

For reprints of other discussions in this series,
or technical data on any E-V product, write:
ELECTRO-VOICE, INC., Dept. 393BD
686 Cecil St., Buchanan, Michigan 49107



Circle 16 on Reader Service Card

Letters

The Editor:

In regards to the recent debate about the technical symbols and the arguments expressed over their merit, I have only to say that the industry in all departments needs to develop definite standards that can be shared with other related fields and other industries. At present, there are so many differences in equipment specifications and standardization references, that it is difficult to view the specifications of a piece of equipment and compare them with those of others with any degree of validity. It is for this reason that I heartily support db's view on the industry standardization of technical symbols.

*James R. Camelford
President
Camelford Recording Studios
Dunnville, Ontario, Canada*

The Editor:

In the October issue of db, the FEEDBACK LOOP column stated that it has had requests for a compact headphone amplifier to be driven from the bus to drive an 8-ohm set.

Several models of such an amplifier are available from Daven, priced at \$39.50 each. Available from stock are the MA90, a 20 milliwatt amplifier; MA-90-75, a 75 milliwatt amplifier. Available soon will be a 130-mW, 2-watt and 5-watt units. Both the 20- and 75-mW models are approximately 1½ inches square, and weigh about 2½ ounces.

We also have available a transistorized interphone amplifier to replace the 101A induction coil system still used by many stations.

An Audio Accessories catalog listing this and other equipment is available from us. If further information, including schematics is required, it can be supplied by the writer.

*Henry Baker
Technical Representative
Daven Division
Grenier Field
Manchester, New Haven
03103*

Robert Bach
PUBLISHER

Larry Zide
EDITOR

Bob Laurie
ART DIRECTOR

Marilyn Gold
COPY EDITOR

Charles N. Wilson
ASSISTANT EDITOR

Richard L. Lemer
ASSISTANT EDITOR

A. F. Gordon
CIRCULATION MANAGER

David Pollens
ASST. CIRCULATION MGR.

SALES OFFICES

New York
980 Old Country Road
Plainview, N.Y. 11803
516-433-6530

Denver
Roy McDonald Associates, Inc.
846 Lincoln Street
Denver, Colorado 80203
303-825-3325

Houston
Roy McDonald Associates, Inc.
3130 Southwest Freeway
Houston, Texas 77006
713-529-6711

Tulsa
Roy McDonald Associates, Inc.
2570 S. Harvard Ave.
Tulsa, Oklahoma 74114
918-742-9961

Dallas
Roy McDonald Associates, Inc.
Semmons Tower West
Suite 411
Dallas, Texas 75207
214-637-2444

San Francisco
Roy McDonald Associates, Inc.
625 Market Street
San Francisco, California 94105
415-397-5377

Los Angeles
Roy McDonald Associates, Inc.
1313 West 8th Street
Los Angeles, California 90018
213-483-1304

Portland
Roy McDonald Associates, Inc.
2305 S. W. 58th Avenue
Portland, Oregon 97221
503-292-8521

ANOTHER
CUSTOM DESIGNED CONSOLE
BY
AUDIO DESIGNS

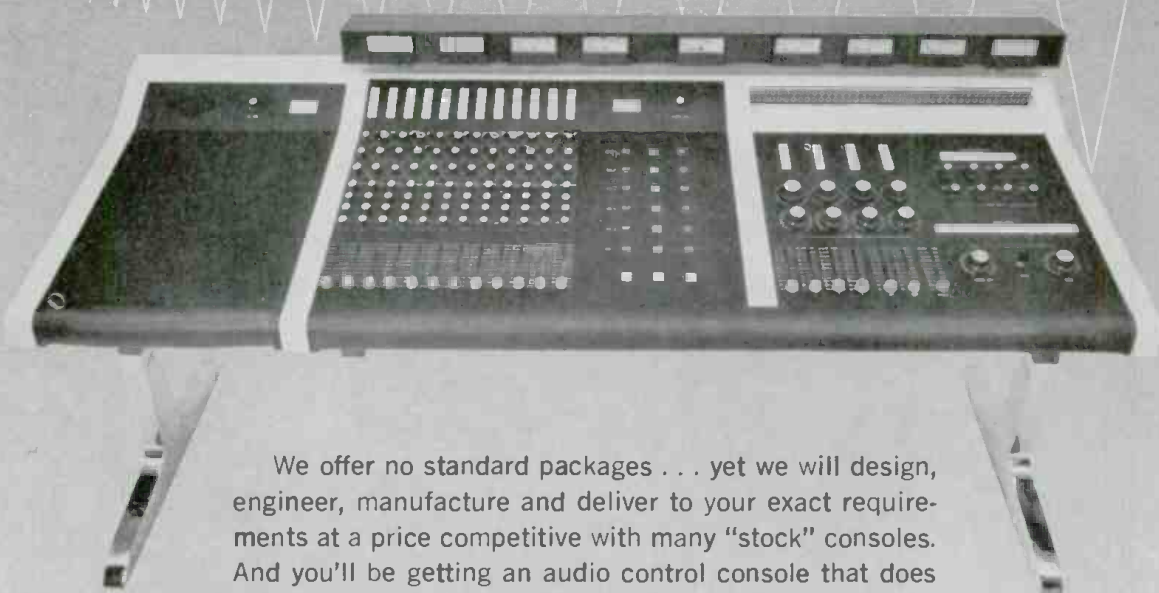

We offer no standard packages . . . yet we will design, engineer, manufacture and deliver to your exact requirements at a price competitive with many "stock" consoles. And you'll be getting an audio control console that does the job you want it to do.

Audio Designs' consoles feature integrated quality components; attractive furniture styling; modular construction; minimum space requirements; flexibility of total patching; complete monitoring facilities; and other unique innovations.

Write or call for details and estimates on your console requirements.

components & consoles

**AUDIO
DESIGNS**

and Manufacturing, Inc.

AUDIO DESIGNS/15645 Sturgeon/Roseville (Detroit), Mich. 48066/(313) 778-8400
Circle 17 on Reader Service Card

**NEW PLUG-IN
INPUT MODULE
FROM
UNIVERSAL
AUDIO
MODEL 2100**



For complete processing
of a low-level audio
program signal

- 8 frequencies of equalization, 2dB steps of boost and/or cut
- three 20dB steps of input attenuation
- Reverberation-send (selectable before and after)
- Straight-line mixer attenuator
- Overload indicator light
- May be used alone as a +18dBm (max.) output amplifier
- Size: 2 1/8" W x 18" L x 7 1/2" Deep

Write for complete specifications.

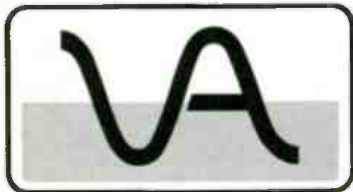

PRODUCTS OF **UAET**
11922 VALERIO STREET
NO. HOLLYWOOD, CALIF. 91605
TEL. (213) 764-1500

UAET UNITED RECORDING ELECTRONICS INDUSTRIES

Circle 15 on Reader Service Card

The Audio Engineer's Handbook

GEORGE ALEXANDROVICH

MULTI-CHANNEL RECORDING-WHY?

• It's no news to anyone anymore. There is hardly a studio left in the recording industry which would dare to compete using single-channel or even two-channel equipment. The lowest number of channels you are likely to find is three or four, but more and more consoles having eight, twelve, sixteen, and even twenty-four channels are being installed. Where is the end?

Who can use this multi-track recording since the end product is two-channel stereo or single-channel mono? What is the purpose of having so many tracks? The answer to these questions is by no means simple. Perhaps the only way they can be answered is by summarizing all the advantages and disadvantages associated with the multi-channel recording techniques and then weighing the results. But this is not the only determination of whether or not we should consider employing this recording technique. The last word is unfortunately with the customer who pays the bills.

It seems that the experience of personnel at any particular studio no longer is a prime factor for judging the studio. More than once I have heard complaints from recording engineers who pick up a telephone only to be asked: "How many channels do you have?" If the answer is three or four, this prospective client hangs up. Is that the criterion for judging the recording capability of a studio?

Actually, what the multiplicity of tracks offers is *convenience*. When there were only single-track machines the task was clear; get a good-sounding mix so that only minor corrections would have to be done in editing and mastering on to disc. The advent of stereo required that two channels, aside from sounding good, had to be in phase with each other with a proper amount of separation between channels and with correct location of instruments (audibly) between the channels.

Now we have eight or sixteen channels. There are several approaches that

can be used in recording. First is the old-fashioned and most expensive (?) one. Each channel is assigned an instrument or group of instruments, along with separate vocal and rhythm tracks. All channels are recorded in one pass. If someone makes a mistake or the sound is unacceptable to the producer—there is another take. There may be several takes before an acceptable sound and balance are reached.

A few years back, I happened to walk into the control room of a medium-size studio when I heard the recording engineer announcing over the talk-back and slating system; "... commercial, take 127". A fairly simple commercial session had turned into a nightmare. Obviously, something was holding up progress. Was it the equipment, the producer or the artists—or was everybody becoming tired after a few mistakes at the start of the session? Nobody knew it then, but it was obvious—a solution to stop this waste of time, talent, and money needed to be found. Multi-track systems with sel-sync recorders so far approach this solution closer than anything else possible. This incident concerning 127 takes, characterizes only a small part of the problem the recording industry is faced with. There are larger groups, orchestras and expensive and famous soloists, whose time in the studio runs into thousands of dollars. The same goes for the studio time. The client pays for studio time. If there are twenty takes instead of five, he has to pay four times as much.

The other way to use multi-track capability is as follows: Let us say there is a scheduled recording session of an orchestra with a singer. If the studio records the orchestra part without the soloist and then the recording of this session is played back through earphones for the singer who in turn sings along with the recording of the orchestra, his performance is then taped on the second track along the first. This is the function of sel-sync. This technique has exploded into the use of multi-

When Stanton engineers get together, they draw the line.

The frequency response curve of the new Stanton 681 Calibration Standard is virtually a straight line from 10-20,000 Hz.

That's a guarantee.

In addition, channel separation must be 35 dB or greater at 1,000 Hz. Output must be 0.8 mv/cm/sec minimum.

If a 681 doesn't match these specifications when first tested, it's meticulously adjusted until it does.

Each 681 includes hand-entered specifications that verify that your 681 matches the original laboratory standard in every respect.

Nothing less would meet the needs of the professional studio engineers who use Stanton cartridges as their ref-

erence to approve test pressings. They must hear exactly what has been cut into the grooves. No more. No less.

But you don't have to be a professional to hear the difference a Stanton 681 Calibration Standard will make, especially with the "Longhair" brush which provides the clean grooves so essential for clear reproduction. The improvement in performance is immediately audible, even to the unpracticed ear.

The 681 is completely new, from its slim-line configuration to the incredibly low-mass moving system. The 681A with conical stylus is \$55.00, the 681EE with elliptical stylus, \$60.00.

For free literature, write to Stanton Magnetics, Inc., Plainview, L. I., N. Y.

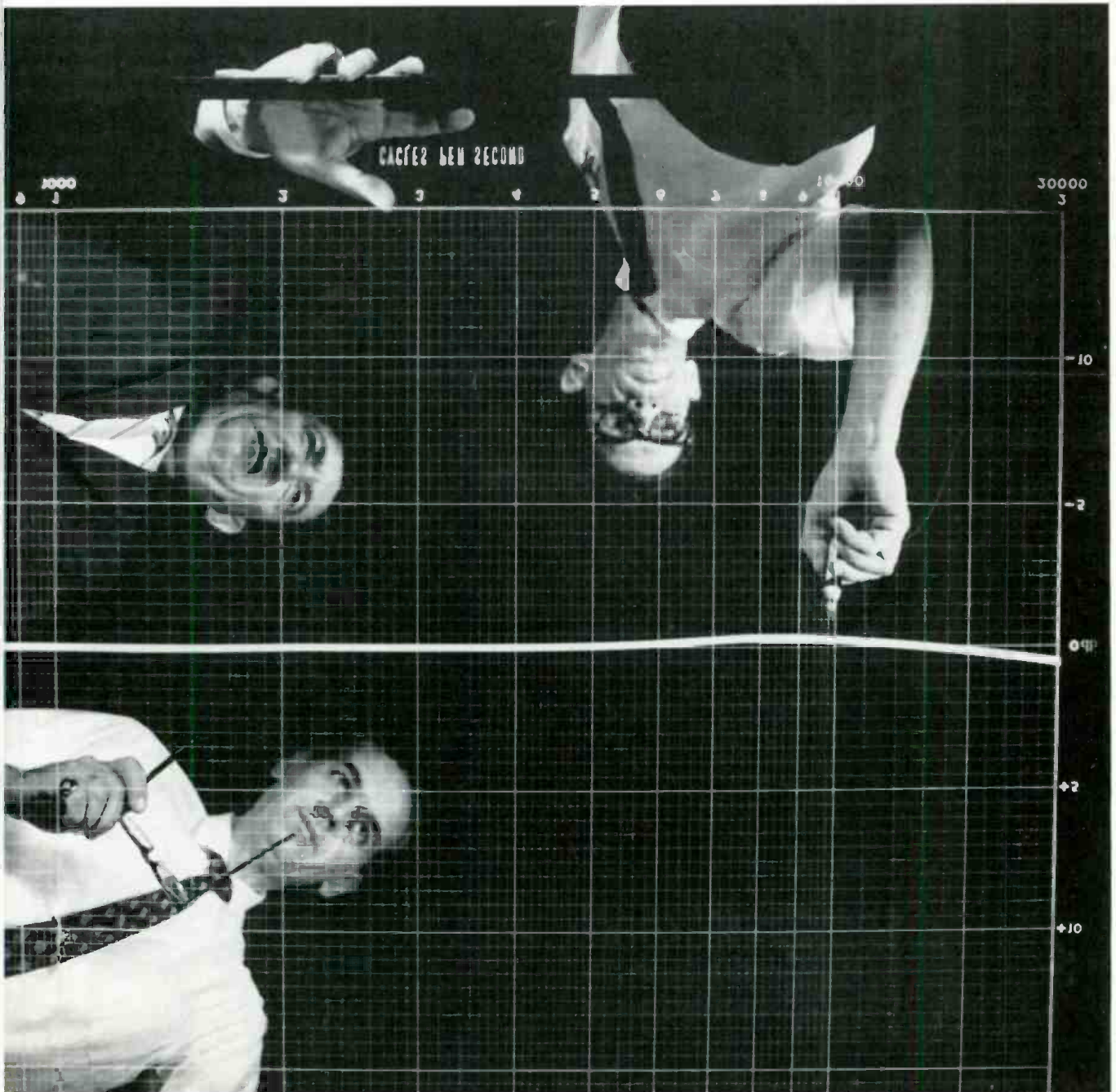

SEE STANTON IN BOOTH 574 AT THE NAB SHOW.

Circle 18 on Reader Service Card

WHERE WILL THE "PHANTOM" PROVE ITS AMAZING POWER NEXT?

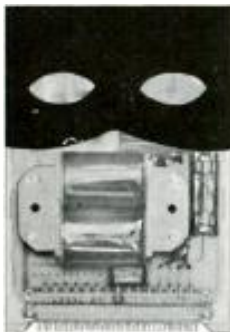

In your studio, perhaps?

The "Phantom" can't resist the challenge of a multi-microphone power supply problem. It may look like a simple plug-in printed circuit card and frame. But it's actually the most unique compatible central powering unit in the world.

Why is it called the "Phantom"? Because you install it in one place, anywhere at all, and it simultaneously powers up to 40 Neumann FET-80 microphones wherever they may be—miraculously, *without* changing existing microphone outlets or wiring.

Plug any other kind or make of microphone into the same outlets and—the "Phantom" vanishes.

Why buy a new \$84 power supply each time you add two microphones? Buy the \$84 "Phantom" just *once*, and don't buy another until you buy your 41st Neumann!

Write to Dept. 102
for free brochure with
complete information.

GOTHAM
AUDIO CORPORATION

2 West 46th Street, New York, N. Y. 10036 (212) CO 5-4111
1710 N. LaBrea Ave., Hollywood, Ca 90046 (213) 874-4444
In Canada: J-Mar Electronics Ltd.



Circle 14 on Reader Service Card

channel equipment to the point where it is becoming an obsession with producers. Splitting a recording into several separate recording sessions has turned them into separate sessions for practically each instrument.

What are the *positive* aspects of this technique? First of all, it provides the ability to have full control of each individual instrument or microphone, not only during the recording session but during the remixing. This makes remixing just as important as any step in the chain of events before the master recording is composed. And I mean *composed*. Because, having such a control over each instrument empowers an engineer/mixer and the producer almost as an orchestra conductor, perhaps even more. Using all the presently available techniques, sound can be re-created and changed to a point beyond recognition. Thus the producers are the composers of a new sound.

Another aspect of the multi-track system is of a more technical nature. You can record each instrument at maximum level on the tape regardless of the final balance. What this means is that during replay or remixing at proper level (lower than recorded) you will produce a better s/n.

Consider single-track recording. Signals from all microphones (or instruments) add up to a combined signal of certain level. This signal, recorded on tape, can be retained only at certain recording level before tape saturation occurs. Almost all individual signals comprising this level are of much smaller magnitude for proper acoustical balance. This places them closer to the noise level on the scale of the dynamic range. Recording each signal on a separate track overcomes this problem.

An additional feature of multi-track recording, already alluded to, is the ability to record each track separately at different times, using the sel-sync feature for each subsequent recording. Since multi-channel consoles also have a substantial number of inputs (at least as many as the recorder's channels) a single section of an orchestra (for example, rhythm) can use several mics, each processed through an equalizer with the total mix recorded on a single track.

Since each input can be individually equalized, lowering the response of the unwanted frequencies (extreme lows and highs), tape noises are reduced substantially by this cutting out of both ends of the spectrum. The point at which rolloff should start is determined by the frequency range of the instrument or voice being recorded. Generally, rolloff has to be employed carefully, especially at the high frequencies, in order not to deprive the information of higher-order harmonics which add to the

STEP UP

...to the finest stereo cartridge in the world!

Ortofon



If you're settling for less than an Ortofon, you're making do with less than the best!

The SL-15T — for the better automatic turntable. \$75.00

The S-15 — for the transcription turntable. \$80.00



Endorsed by Elpa because it successfully meets the stringent standards of performance Elpa demands. Write for full details on The Complete Ortofon line of Cartridges and Tone Arms.

Elpa Marketing Industries, Inc., New Hyde Park, N. Y. 11040

Circle 13 on Reader Service Card

the birth of the AR-5

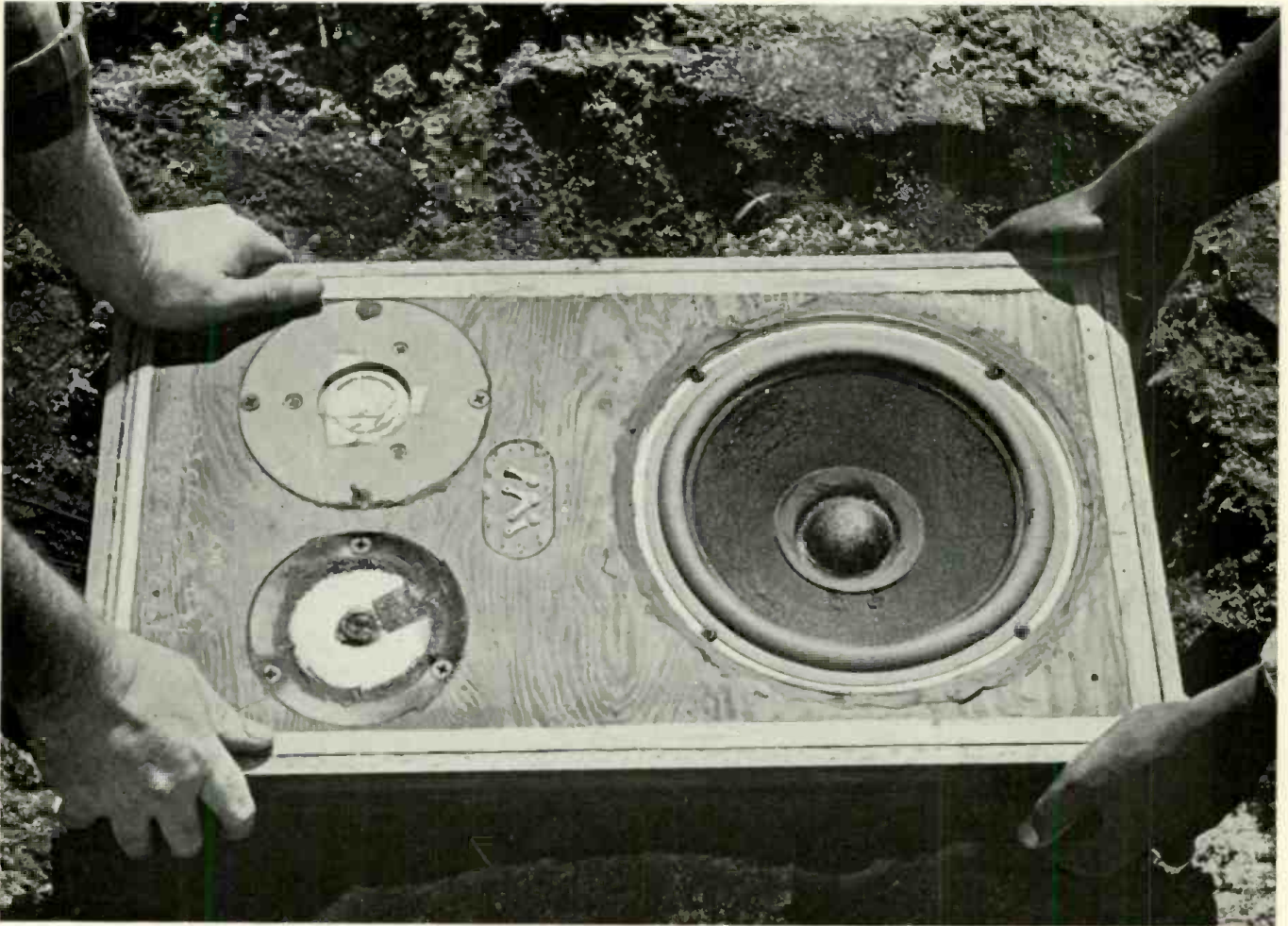

This is a photograph taken immediately after our final test of the prototype of the AR-5. The speaker system was measured while buried in a flat, open field, facing upward, its front baffle flush with the ground. This technique provides more accurate information than indoor tests, especially at low frequencies, where the precision of such measurements is adversely affected by the limited size of an anechoic chamber.

Our standard of accuracy when measuring the AR-5 prototype was the sound of live music, that is, absolute accuracy of reproduction. At AR, the best response curve for a speaker system, like that for a microphone or amplifier, is the one which most closely matches the input.

The specifications which AR advertises are obtained from production units, not prototypes. All AR-5 systems must match the performance of the prototype within close tolerances. To see that this is true, every AR-5 is tested numerous times in ways which permit it to be compared to the prototype. Only in this way can we be certain of what we have made, and consumers certain of what they are being offered.

AR speaker systems have uniformly received favorable reviews in publications which carry test reports. But even more accurate and comprehensive tests than most of these magazines perform are made on the AR production line, of every AR speaker system which will go into a listener's home.

The AR-5 is priced from \$156 to \$175, depending on cabinet finish.

ACOUSTIC RESEARCH, INC., 24 Thorndike Street, Cambridge, Mass. 02141

Overseas Inquiries: Write to AR International at above address

Circle 21 on Reader Service Card

www.americanradiohistory.com

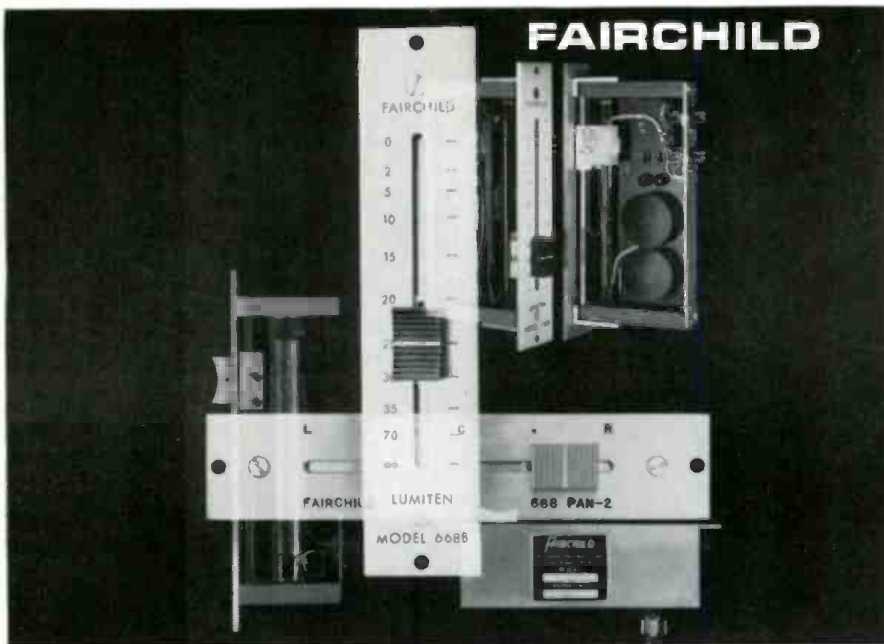

THE NEW FAIRCHILD LUMITENS • Fairchild introduces a complete new line of noiseless attenuators with 7 new advantages: 1. Transistorized drives require only minute current to actuate circuit. 2. Multi-channel operation with common light sources to all channels guarantees tracking to within ½ db between channels. 3. 4 channels or more can be driven by a single actuator. 4. Infinite resolution from 0—∞. 5. Plug-in light source allows instantaneous replacement. 6. Improved mechanical construction of slide faders' precious metal sliding contacts gives long trouble-free life, offers adjustable feel. 7. Plug-in, remote, and slide-wire models range from one to four channels and are designed with ultimate versatility in packaging.

Contact your Fairchild Recording Distributor or write **FAIRCHILD RECORDING EQUIPMENT CORPORATION**, Dept. DB-3, 10-40 45th Avenue, Long Island City, New York 11101.

Fairchild Lumitens (available in 600 and 150 ohms) include: 66811 Attenuator, 668 PAN-2 Pan Pot Actuator, 668 AC Remote Cell Actuator, 668 ST11 Stereo Attenuator, 668 RSB Remote Stereo Attenuator, 668 MC 4-channel Master Control Attenuator card, 668 RAB Remote Attenuator packaged on compact PC card, 692 D1 Single Remote Attenuator, 692 D2 Two Independent Attenuators. Slide Wide Fader: SWL600 (600 ohm L pad).

Circle 20 on Reader Service Card

STEP UP

... to the finest tape splicing system in the world!

EDITall

Order direct! Start with the Introductory Editall tape splicing kit—the KP-2. Includes splicing block, 30 splicing tabs, carbon marking pencil, cutting blade and a complete instructional guide for better tape splicing. Only \$3.50. Includes postage and handling.

If you're settling for less than the Editall System, you're settling for less than the best!



Endorsed by Elpa because it successfully meets the stringent standards for performance Elpa demands.
Elpa Marketing Industries, Inc., New Hyde Park, N. Y. 11040

Circle 19 on Reader Service Card

clarity and fullness of the sound. It becomes clear that low-end equalization on the bass track and violin track would be quite different. Where there may be no rolloff of 30 Hz on the bass track here may be cut at 100 Hz of the violin track. One would not attenuate the high end of the violin whereas bass may be cut off at few thousand hertz.

By dividing the signals between channels it is possible later on to add reverberation to separate tracks as well as substitute some of the vocal tracks with foreign-language recordings (or leave it out entirely for the sing-along records).

The remix session with multi-track tape becomes much like the original recording session except that there is no group or orchestra—only tape, the recording engineer/mixer, and the producer. Producers like that; especially, when the original sessions were good in all respects. Then the remixing and mix-down to stereo or mono is easy. If all the tracks were recorded at maximum allowable level without overload, chances are that the mixdown noise will be as low as in the original.

What if something went wrong and passed undetected until the time of the remix session? If one track was bad, then it can be left out or re-recorded later by summoning the artists who recorded it back for another session.

Next month, I will continue this discussion of multi-track recording including problems of the use of wide tape and repeated use of the same tape.

MOVING?

Have you sent us a change-of-address notice? It takes time for us to change your plate so let us know well in advance of your move. Be sure to send us the complete new address *as well as your old address*. Include both zip numbers. Keep **db** coming without interruption!

BACK ISSUES AVAILABLE

A limited number of back issues of **db** are available to interested readers who may have missed or misplaced earlier issues. When ordering please indicate date of issue desired and enclose 75c for each copy.

CIRCULATION DEPARTMENT
db—The Sound Engineering Magazine
980 Old Country Road
Plainview, N.Y. 11803



“The Dolby system solves the noise problem of tape re-mixes and sub-masters,”

says Phil Ramone, Chief Engineer of A&R Recording Studios in New York.

“With today’s complex multi-track recording techniques, control of tape noise is especially important. The 10-db reduction of hiss, print-through and crosstalk the Dolby gives me, permits as many re-

mixes as desired without adding successive increments of noise.”

For your recording of the “now” sounds of today, or for classical music, you can conquer tape noise with the dependable Dolby A301 system.

DOLBY LABORATORIES INC.

333 Avenue of the Americas, New York, N.Y. 10014 □ Telephone (212) 243-2525 □ Cable: Dolbylabs New York
Circle 27 on Reader Service Card

The Feedback Loop

ARNOLD SCHWARTZ

• Summarizing from last month, the ABC switching system enables the operating technician to preselect any one of fifty feeds at various locations in his technical area. The switcher consists of a centrally located bank of fifty-position step switches with a control module at each input point. A simplified block diagram of the system is shown in FIGURE 1. Remote feeds and programs generated in the studios are fed to the switcher through distribution amplifiers. All signals are now available at the switcher terminal blocks. The sixteen remote feeds and the appropriate studio feeds are interconnected to each step switch. Upon command from the control module the step switch will connect the indicated feed to the input channel. Failure in this type of system can be more serious and wide ranging than a comparable failure with localized or with jack fields. For this reason, more than casual attention had to be paid to reliability, and to the problem of component failure.

Two parallel approaches were used: The first concerns design and choice of components in order to minimize failures; the second provides alternate means of operation in the event of failure. Obviously, rugged switch construction is a must, and a close-up photo of the step switch is shown in FIGURE 2. The contacts handling the audio signal (the left-hand pair), are gold plated.

New York City has a very high level

of air pollution, and air-borne contaminants, especially the hard gritty particles, can affect the operation of an unsealed step switch. If allowed to penetrate the switches, this grit will accelerate wear and decrease reliability. For this reason the switches were enclosed in a small room with an air filter and conditioner. The worst of the air-pollution problem is avoided while the temperature and humidity are maintained at a reasonable level.

Dual power supplies, either one capable of supplying the full load, furnish the necessary d.c. for control and actuation of the switches.

In the event of switch failure, there is a patching arrangement for rapid substitution of the defective unit. The switches are arranged in rows of eight: seven are normally in use and the remaining one is a spare. Substitution of the spare switch is made by connecting the input and output control cables and the signal cable of the defective switch to the connectors of the spare. The control cables can be seen, normally connected, just below the switch itself in FIGURE 2.

The audio jack which is located just below the control cables does not have a patch cord since the signal is fed through the jack's normally-closed contacts. FIGURE 3 shows a row of switches mounted in the frame; the fifth switch from the left below being the spare—

this is the switch without the control cables plugged in. When it is necessary to put the spare into operation, special cables are used. A conventional tipping-sleeve patch cord is used to re-route the audio. In the event of routine maintenance, a similar substitution can be made. This patching system adds flexibility since by suitable interchange of step switches and associated control modules, a control-room function can be completely revamped without any wiring and within a few minutes. Interchange of control modules, as we pointed out last month, is simplified by a plug-in arrangement.

An interesting application, and one not originally envisioned, occurred when the ABC Radio news department requested that the switching module be used as a monitor selector on their overseas communication units (ocu).

Because of its compact size, large selection, convenience of the readout, and rapidity of selection, the module is ideal for the fast-action news room. Four overseas incoming and outgoing lines are available at the ocu. The

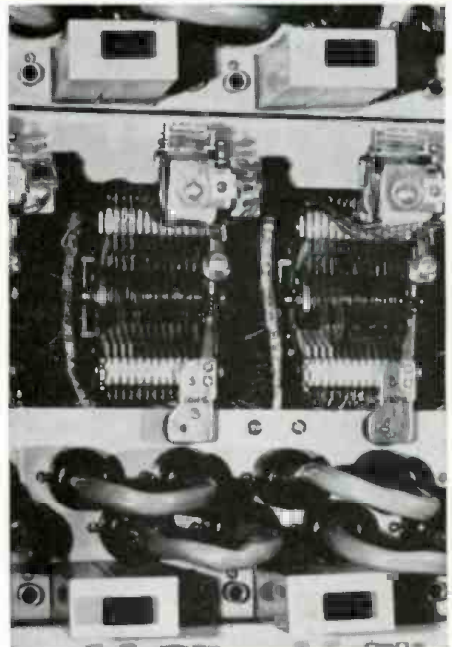

Figure 2. Two of the rugged step switch assemblies used at ABC Radio.

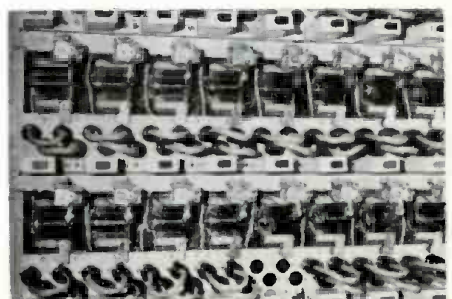

Figure 3. The switches mounted in their frame. The switch without connecting cables on the lower row is a spare.

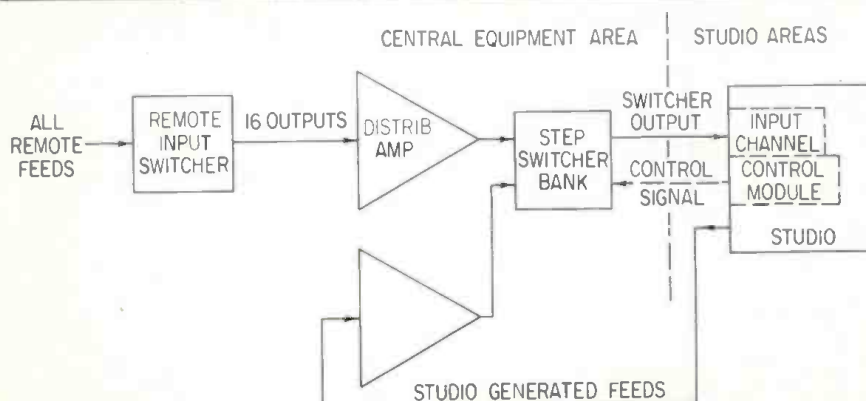
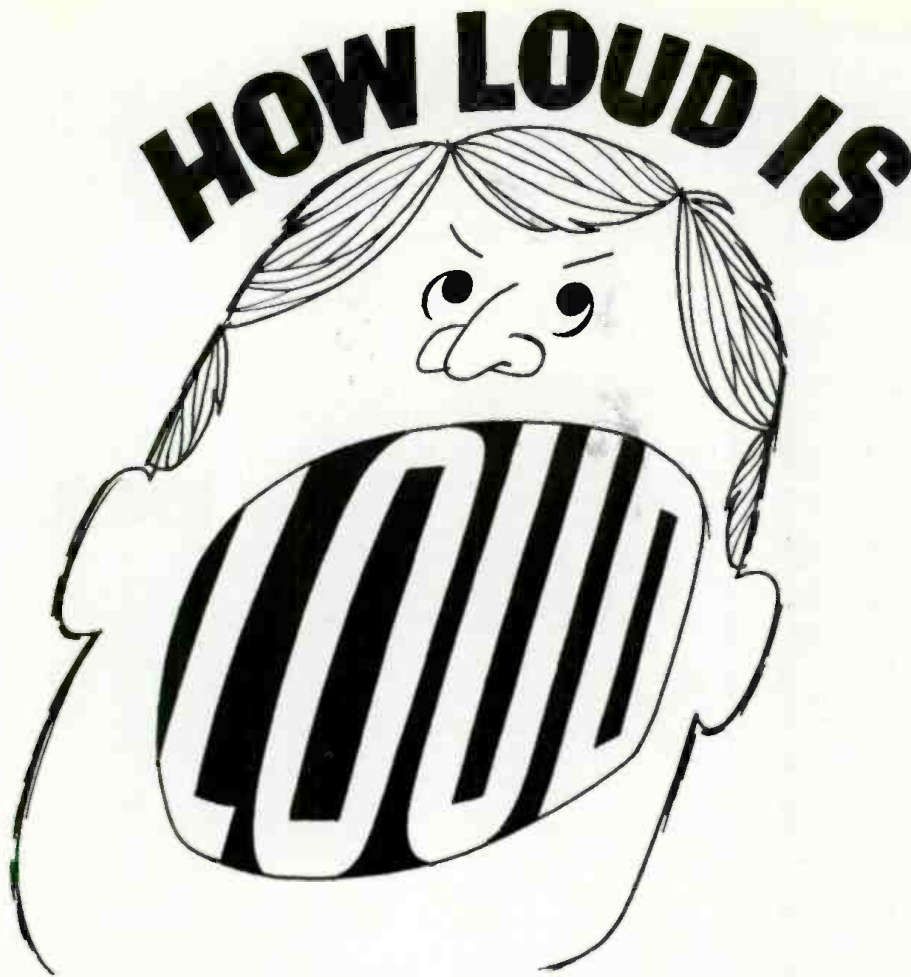

Figure 1. A simplified block diagram of the ABC Radio Network switcher system.



Our CBS Laboratories Loudness Indicator will tell you.

It's the only indicator designed to measure what the human ear hears!

It's especially effective for measuring loudness levels in remote broadcast pickups. Permits you to monitor loudness levels accurately. Indicates when your signal lacks "presence."

Fact is, it's the *first* practical operating instrument that gives you a visual indication of what your audience actually hears. Another important plus: it's an indispensable tool for measuring loudness levels to determine if they're in accordance with FCC requirements!

Comes with a standard 19-inch mounting rack. Easily removable for field use. Indicates over 30 dB range. Separate output jack for remote monitoring.

Write. Or better yet, call us collect: (203) 327-2000.

SEE IT AT THE NAB - BOOTH 105



PROFESSIONAL
PRODUCTS



CBS LABORATORIES

Stamford, Connecticut 06905
A Division of Columbia Broadcasting System, Inc.

Circle 26 on Reader Service Card

**4 or 8 Channel
BUDGETABILITY**

**Need 4 or 8 channel mixer-equalizer capability?
Are you shocked at console prices of \$5000 up?
Would you like to spend less than 1/2 the amount?
... then check with Gately before you buy!**

GATELY ELECTRONICS
57 WEST HILLCREST AVENUE
HAVERTOWN, PENNA. 19083
AREA CODE 215 • HI 6-1415
...have you checked Gately lately?

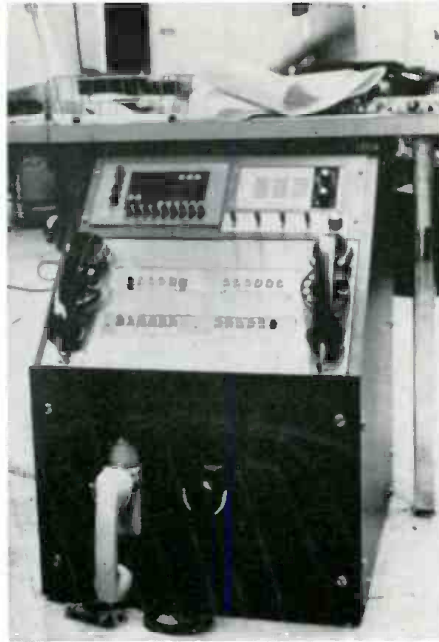

Figure 4. The ABC Radio news department uses this console as a monitor selector for their overseas communications units (ocu).

operator must also have access to numerous other feeds. The step switches were added and wired right at the central switcher frame, and since *all* feeds are conveniently available at the switcher frame terminal blocks, it became a relatively simple job to make the necessary connections.

FIGURE 4 shows the ocu. The control module is located in the upper right section, and the monitor amplifier-speaker is in the upper left-hand side. Immediately below the monitor are four lever-key switches which select the outgoing overseas circuit. Incoming circuits are selected by the control module. To the right we can see the talk-back microphone mounted on a goose neck. Telephone apparatus takes up the lower half of the console.

I think that the approach of the ABC switching system described here suggests many other possible applications, not only for larger facilities, but for medium and small installations as well. For example, the number of switches and the number of selections available on each switch can be matched to the individual requirements. Smaller installations may house the switches in a conventional rack along with other equipment while larger installations must use separate racks or equipment frames. Of course a step switch is only one of many possible approaches to designing a comprehensive switching system. I think further discussion of switching systems is needed and hopefully some of the points brought out here will stimulate that kind of response.

Sound with Images

MARTIN DICKSTEIN

COLORAMA

• In the last fifteen years or so have you been in Grand Central Station in New York City? Do you then remember looking high up on one end and seeing a huge picture presenting some vivid scene of the season? Did you perhaps wonder how such a large picture was made? Perhaps we can take this opportunity to answer a few of the questions that you might have asked. However for those who have not seen this display, it would be best to describe it briefly.

At the east end of the huge, domed station, a very large stationary image is shown, bright and colorful, in keeping with timely events or the seasons. During this winter, a scene of carolers was presented in which five singers stood outside a window into which we could look to see a family facing out from around their Christmas tree. The mother, within the room, was aiming a small camera at the singers.

Another recent scene was a panorama of the harbor of Hong Kong at dusk. Still another, the arrival of the liner France to New York harbor on its maiden voyage. Another was the lineup of the famous Rockettes, the precision dance team seen in stage presentations at the Radio City Music Hall, also in New York.

The image itself, which can be easily seen from almost everywhere in the main terminal area, is actually a transparency, eighteen by sixty feet, the largest in the world.

To produce a giant image of these proportions, it obviously is necessary to begin with a special camera using large film sheets to make a negative big enough to permit sharp enlargements of huge size. So, a special camera was adapted to use eight by twenty-inch film sheets. To cover this out-sized film, the shortest lens that can be used has a focal length of 14 inches, slightly more than 350 mm).

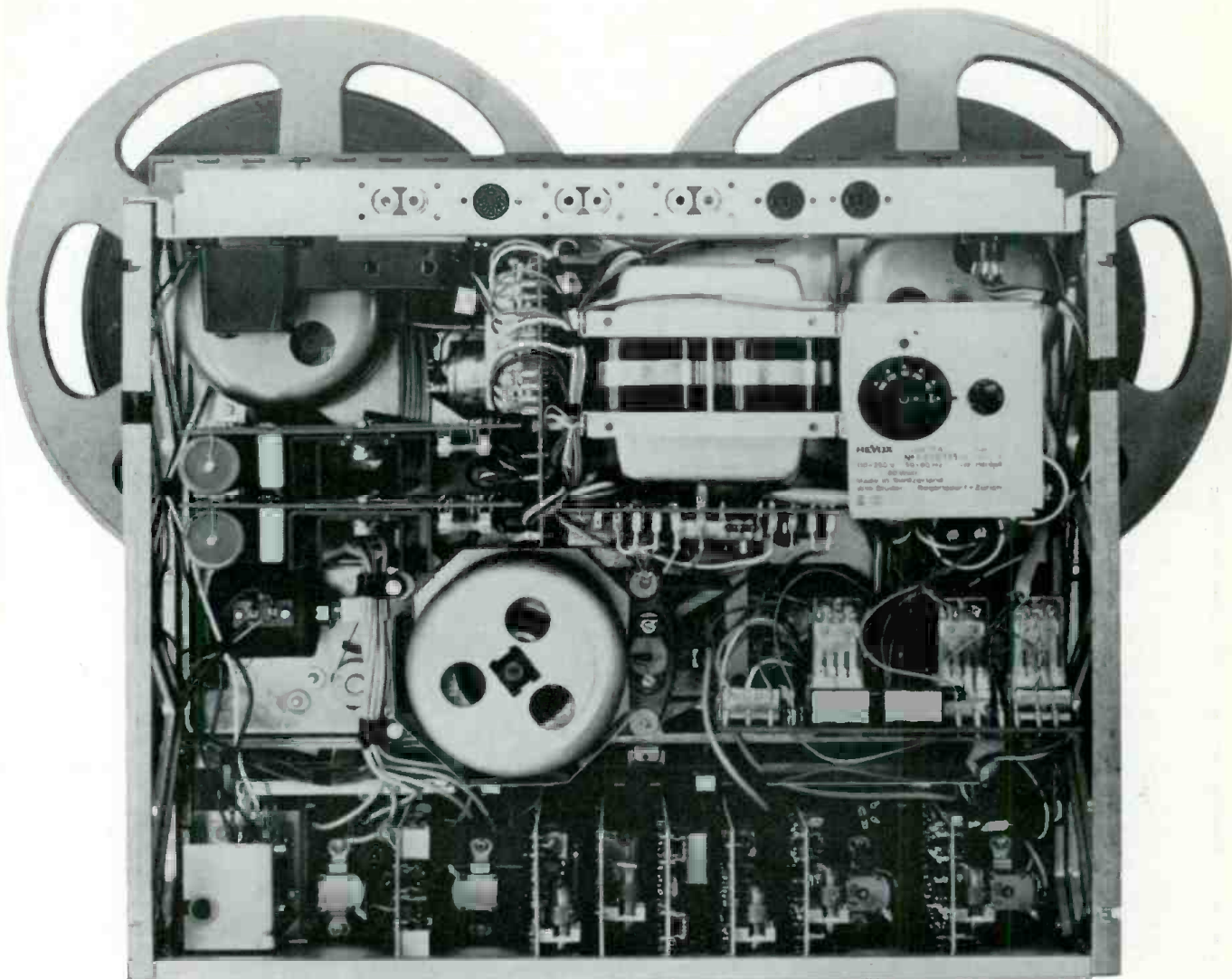

the inside story of Willi Studer

The Revox A77 is Willi Studer's brain child . . . born from years of experience designing magnetic recording equipment for the broadcasting and recording industries. This is a great machine that comfortably outperforms recorders costing even three times as much. Audio Magazine reported "the flattest machine we have ever tested."

We've shown you the inside, too often overlooked. Let your Dealer show you the elegant styling and fine finish. Priced from \$499.00 at leading high fidelity specialists.

To know the detailed inside story on Willi Studer's Revox A77 read the fully descriptive story from **Revox Corporation** 212 Mineola Avenue Roslyn Heights N.Y. 11577 Telephone (516) 484-4650

In Canada contact
Tri-tel Associates Ltd Toronto Canada

REVOX

Circle 25 on Reader Service Card

**When you're ready
to buy your next
professional
recorder...**



Look for:

LOW NOISE Pure sound reproduction is the minimum requirement for a professional recorder. Listen carefully for hum and other machine-produced noises—marks of an "amateur" machine. Incidentally, the noise level of all Crown recorders is lower than that of most other professional recorders. (Guaranteed minimum S/N of 60db at 7½ ips.)

WIDE BAND-WIDTH Any professional recorder will cover all the audible sound spectrum. Now try to find one with the band-width safety margin of a Crown. (Guaranteed minimum of ±2db, 30-25 kHz at 7½ ips and 30-15 kHz at 3¾ ips.) In side-by-side comparison, you'll discover that reproduction on a Crown at 3¾ ips is comparable to that of other professional recorders at 7½ ips, giving you savings of 50% on tape in many recording applications!

MINIMUM DISTORTION Wow, flutter and other signal distortions should be imperceptible at 7½ ips for professional quality tapes. Crown guarantees a minimum of 0.09% wow and flutter at 7½ ips.

FLEXIBILITY Look for a recorder with a full range of professional refinements. More than with any other professional recorder, you can "do anything" with a Crown—record sound-on-sound, create special equalization and echo effects, A-B monitor while recording, mix four microphones and much more.

INVESTMENT Professional electronic equipment is a good secure investment, with a slow rate of depreciation. A Crown is insured against obsolescence with a design acclaimed by professionals "years ahead of the industry." With only ten moving parts, normal care and routine service will assure like-new performance for ten years. In 1978, you'll be glad you purchased the very best—a Crown.

Write to **Crown International**
Box 1000, Dept. DB-3
Elkhart, Indiana 46514

MADE ONLY IN AMERICA

Circle 23 on Reader Service Card

The size and weight of the camera unit makes picture taking quite difficult, along with extra problems incurred in the required lighting. To achieve the shot of the Rockettes, the set up had to be made after the last performance. Special lighting had to be brought in, a special reflector curtain to bounce the light was hung, and a total of 36 people across a 72 foot stage had to be in perfect focus. A series of sample shots was made with a 16-in. lens. This was developed during the early morning hours prior to the actual shooting to be sure of the settings and lighting. All went well.

For the shot of the Hong Kong harbor, a spot was found high on a cliff overlooking the scene. A picture of a family closing up their summer cottage was taken from atop a twelve-foot ladder which was on a platform mounted on a station wagon which had all four of its wheels jacked off the ground for rock-like stability.

In attempting to shoot an action picture, it was found that the top speed of the camera, 1/150 of a second was not good enough. A special high-speed shutter mounted on a 17-in. lens with a maximum aperture of f/17 was found which allowed a 1/250 sec. speed. By shooting wide open and pushing the film during processing, an action shot of a football play from the sidelines was achieved.

For the picture of the France, a specially modified aerial camera was taken up in a helicopter. This camera was used with a 24-inch f/5.6 lens and a 75-foot roll of film 9½-inches wide. This was driven through the camera by an electric motor to produce forty of the special negatives needed by the Colorama process. The selected negative was rushed through processing in Rochester, assembled, returned to N.Y. and mounted in a total of 96 hours. The picture was on display before the ocean liner had left port.

As usual, there's a fooler in the bunch. The picture of the warmly-clothed carolers in the Christmas scene was actually taken in the studio in Rochester. The "frost" was applied to the window with a wet sponge, live bushes were moved in and sprayed with "snow", and electronic flash units with blue filters were used to simulate moonlight. The entire scene was actually photographed on a summer afternoon.

This Colorama display has been on exhibition since May, 1950. The picture is changed every three weeks during the early morning hours (by four men) so that a new scene will be on display for the Monday morning public.

In the making of the transparency, a section of the eight-by twenty-foot negative measuring only 4-7/8 by 16¼ inches is actually used in the enlargement. The 18-foot high en-

largements are then carefully registered, spliced together with transparent tape, rolled on an 18-foot spool, packed in a special box and shipped to New York City from Rochester. The half-ton load is then unpacked, the spool mounted on a miniature railway car and rolled out in place. The total image, equivalent in area to more than 10,000 35mm negatives, is illuminated from behind by more than a mile of cold-cathode tubes.

At the very next opportunity you get to walk through N. Y.'s Grand Central Station, look for this giant display. You can't miss it. For a few moments, the echoing hubbub of the rushing public will disappear and the imagery of the Colorama will take its place.

ERRATA

In the caption of FIGURE 1 of the column on the camera used in the Apollo 8 flight (January page 10), we indicated that the camera shown (with the viewfinder) was similar to the unit used by the astronauts on their trip around the moon.

In point of fact, the camera with the peep-through viewfinder was an earlier version that was used with the zoom lens as shown. On the actual flight, however, the zoom lens was not used (or even carried along on the mission).

The camera actually used was more like that in FIGURE 2 with a fixed-focal-length lens and no viewfinder. You will recall that ground control had to tell the camera operator in the capsule to move the camera in order to get the image into the center of the screen. The astronaut had no monitor or viewfinder so he could not tell exactly where the camera was pointed.

CLASSIFIED

Classified advertising is an excellent and low-cost way to place your products and services before the audio professional. If you are a prospective employer seeking skilled help or an employee seeking a change you will find that the classified pages of **db** reach the people you want. Special low rates apply for this service.

WINSLOW BURHOE HAS A BEARD.

And more than that he has over ten years experience in direct radiator speaker design plus formal training in physics, electronics and music. His experience in the design, manufacturing and quality control departments of two of the top loudspeaker manufacturers led him to believe that he could significantly improve the sound quality of currently available loudspeakers.

So he founded EPI and his first product is probably the finest bookshelf size loudspeaker ever designed. Its accurate tonal balance, exceptional dispersion characteristics and large power handling capacity make it unique in a field where almost every speaker today is quite good. His happens to be better.

Like most bookshelf models, the EPI won't reproduce the bass drum used by the Harvard Band nor 16 foot organ pipes even though its low end is tighter and more solid than any speaker in its class. If very low frequencies are important to you then you may be interested in Winslow's Studio Monitor which will soon be available. It is naturally larger but the total overall response is greater — and so is its price.

If you would like more information on what promises to be one of the most exciting new developments in loudspeakers from an exciting, new (and small) company please write for literature. The printing isn't particularly fancy but when you're just starting out you'd rather put your money where it counts — in the product.

EPICURE PRODUCTS, INC.



185 Somerville Ave., Somerville, Mass. 02143

Circle 24 on Reader Service Card

www.americanradiohistory.com

Editorial

IN MANY FIELDS OF CONTEMPORARY CULTURE, the fine artist has reversed himself to emulate and expand upon the talents of the professional. In art, for example, this movement was initiated by the satirical "advertising" canvasses of Andy Warhol. One fascinating result was that commercial artists and illustrators were stimulated, in turn, to produce some of the most imaginative examples of this new "modern art". And now, *real* advertising posters are collected and hung in fine art galleries!

Similarly, the "today" sound has brought the audio engineer closer to the creative source of music than he had ever dreamed possible. Sound and light shows, discotheques, performances depending on electronic instruments and music synthesizers are a few of the areas that feature audio tools in their artistic expression.

And now the trend is to bring these audio tools to the forefront as artistic expressions in their own right.

Who is better qualified to do this than the audio engineer himself?

Editor, "distortionist", refiner, mixer and mentor to this generation of music makers, the audio pro who wants to break out is uniquely qualified to create his own new audio sound.

While the possibility of that kind of artistic achievement may seem remote to most engineers, many pros can seize this unparalleled opportunity for creative technology. Many of us have the talent to create potentially artistic equipment. We no longer need design tools strictly to reproduce or amplify music or the human voice. Our field has burst open with this challenge of transforming audio from a background support to a prominent creator of musical art.

For audio engineers, the excitement has just begun.

R.B.

Improved Monitoring With Headphones

HOWARD T. SOUTHER

Last month the inadequacies of present monitoring facilities were discussed. In this installment, a practical design for an electrostatic element is detailed.

PRIOR WORK IN THE SUCCESSFUL DESIGN and manufacture of electrostatic loudspeakers suggested the following advantages and swayed the choice to this class of generator for headphones. Distinguishing features of electrostatic elements were these:

1. An extraordinarily light and strong diaphragm material was available from electrostatic loudspeaker production. This was a stable, strong polyurethane film of less than 0.5-mil thickness, offering high dielectric strength, and weighing less than several millimeters of the air adjacent. This appeared to offer a solution for the elimination of high-frequency-degrading mass.

2. The outstanding characteristic of electrostatic elements is the unusual smoothness of pressure response. They are free from peaks and valleys in the curve displaying relative response as a function of frequency. The corresponding regularity of phase avoids waveform distortion in the reproduction of transient signals. While it is true that the ear tolerates some distortion, attaining a threshold of about 3 per cent, smoothness and freedom from distortion is an important determinant in the reduction of fatigue with prolonged listening. No systematic study of these criteria, unfortunately, has yet been undertaken.

3. High conversion efficiency is an attribute of electrostatic elements, for the thin, radiating film does not share its energy with hot voice coils, or with high eddy-current and magnetic-hysteresis losses. Since the dielectric is principally air, even these insulation losses are significantly lower than in other transducers.

The nature of electrostatic transducers is primarily that of a capacitive reactance, and as a consequence, they operate at a low and variable power factor. The place where dissipation occurs is in the internal resistance of the power source, which must supply the "wattless" component of the condenser charging current. In tube amplifiers, this previously required special care in design; in modern solid-state circuits most difficulties in this regard have been overcome through very low internal impedance and transformerless coupling.

FREEDOM FROM DISTORTION IN ELECTROSTATIC ELEMENTS

Earlier we suggested that system distortion, if kept to values

Howard T. Souther is vice-president, engineering, Koss Electronics Inc., Milwaukee, Wisconsin.

under 3 per cent, was of secondary importance. Low signal power requirements cause the addition of no significant distortion products leading to the headphones. If a push-pull, three electrode arrangement of the electrostatic element is considered, we find that a virtually distortionless system is possible. Observe the circuit and the equation for FIGURE 1.

The equation shows that the force on the diaphragm is free of non-linear distortion. However, this is not so for a two electrode circuit:

$$F_{oc} (E_{ac} + E_{dc})^2 = E_{ac}^2 + 2E_{ac}E_{dc} + E_{dc}^2$$

The first term E_{ac}^2 gives a constant force. $2 E_{ac}E_{dc}$ is proportioned to the signal voltage and E_{dc}^2 is a distorting force. The magnitude of the third term showed that only the three electrode push-pull configuration could satisfy our requirements, for another empirical rule standing the test of time may be invoked; *i.e.*, the ear recognizes 3 per cent distortion, tolerates 5 per cent and rebels at 10 per cent. Certainly we must remain below the 3 per cent figure for total system distortion. In choosing the three-element configuration we achieved unexpected bonuses in low distortion. Not only did the final product exhibit no second-harmonic distortion, but odd-order harmonic distortion expected from asymmetrical variations in element construction turned out to be almost immeasurable. Those that did result were ascribed to the small coupling transformers in the headphones.

While our enthusiasm over the possibilities of an electro-

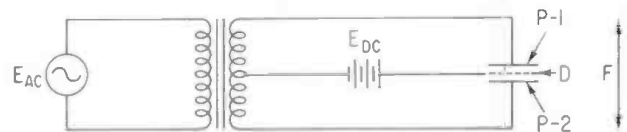

Figure 1. A push-pull circuit for electrostatic elements. The formula is: $(E_{dc} + E_{ac})^2 - (E_{dc} - E_{ac})^2 = 4E_{dc}E_{ac}$ where P1 and P2 are perforated metal plates transparent to sound; D = compliantly mounted conductive diaphragm; E_{dc} = polarizing voltage; E_{ac} = applied signal voltage; and F = force on the conductive diaphragm.

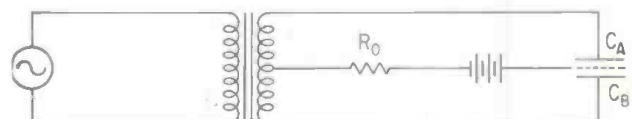

Figure 2. A push-pull circuit for electrostatic elements employing a long time constant for the polarizing voltage.

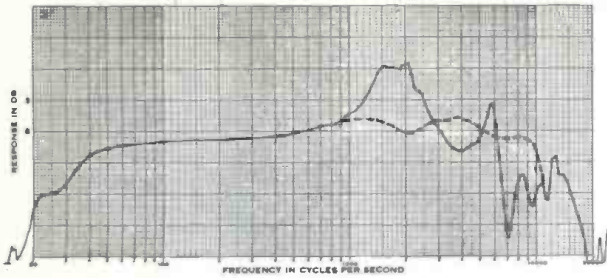

Figure 3. The undamped response of the open electrostatic phone element before the application of acoustic resistance, baffles, grills, and rear cup. The dashed line shows the effect of resistance applied adjacent to the element.

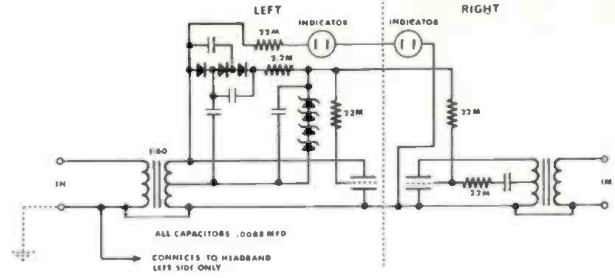

Figure 5. The electrical circuit of the ESP-6 headphone showing the self-polarizing method.

static headset were mounting at consideration of the push-pull advantages, we were taken aback by the requirement for E_{dc} , the polarizing voltage, with its attendant disadvantages of complexity, weight and necessity for high d.c. potential. We had expected the need for coupling transformers, and these offered no obstacle, as they appeared in many conventional headsets. However, the polarizing circuit envisioned connections to the a.c. powerlines, extra wiring, components, added weight, cost, and inconvenience to the user.

THE POLARIZING VOLTAGE

The disadvantages of the power-supply requirement could easily have ended the project if a solution were not forthcoming. No matter how superior the performance of the phone might be, unless it could achieve market-place acceptance, it could not subscribe to the precept that a true development must sustain itself.

An imaginative study of the basic circuit disclosed a solution to the power-supply problem which was startling in its simplicity. While a relatively high polarizing voltage was required, the current requirements for this potential were virtually non-existent.

Rather than the a.c. power mains, a source for the polarizing potential existed within the headphone itself: the *signal* voltage. It was evident that if the time constant of the polarizing circuit was long, the charging effect of the polarizing circuit upon the signal source would not affect the signal in the range of frequencies of interest. No demand would be made upon the signal other than to occasionally charge the

vibrating plate as the initial polarizing charge dissipated itself very slowly through the minute leakage paths. These leakage paths have no perceivable effect on performance if care is exercised in the electrostatic design.

THE SELF-ENERGIZING POWER SUPPLY

In the study of supplying the electrostatic charging potential for the moving diaphragm of the phone, one remarkable feature displayed itself at the outset.

Electrostatic devices are usually regarded as inherently non-linear, because the charging potential on the diaphragm varies inversely with the square of the distance of separation with the stator plate. Observe in FIGURE 2 that a large charge has been placed on the mobile diaphragm.

We may now consider that the charging circuit is disconnected if the time constants R_0C_a and R_0C_b are very long. We see that the force acting on the diaphragm is determined only by the magnitude of the unvarying charge on the diaphragm together with the electric field established by the signal voltage between the stationary electrodes. Importantly, this will be independent of the position of the diaphragm in the space between the electrodes. As a consequence, many of the limitations previously regarded as inherent to an electrostatic system will not limit the performance of the system.

As an example of the features thus provided, it is no longer necessary to restrict the allowable motion of the diaphragm to a small fraction of the separating distance to the stator plate in order to sustain linearity. In addition, the restrictions on allowable signal voltage to polarizing voltage disappear.

STABILITY OF THE DIAPHRAGM

Static stability of the diaphragm is achieved simply by increasing tension to the degree of stiffness necessary in order to overcome the electric field forces generated by the polarizing voltage, in producing successful experimental models, control of this static tension was assisted vastly by the existence of carefully controlled stretchers available from concurrent electrostatic loudspeaker production.

To prevent the stator plates from pulling in the diaphragm, the large resistance in series with the power supply, as shown in FIGURE 2, creates essentially a condition of constant charge operation on the diaphragm, and reduces the charge of the diaphragm regardless of position with respect to either plate.

Hunt, in his book *Electroacoustics*, has shown that if the r-c time constant of this polarizing circuitry is at least four times greater than the time interval of one-half cycle of the lowest frequency to be radiated, the diaphragm will be *dynamically* stable at any location between the plates.

PRACTICAL DESIGN OF THE ESP-6 PHONE

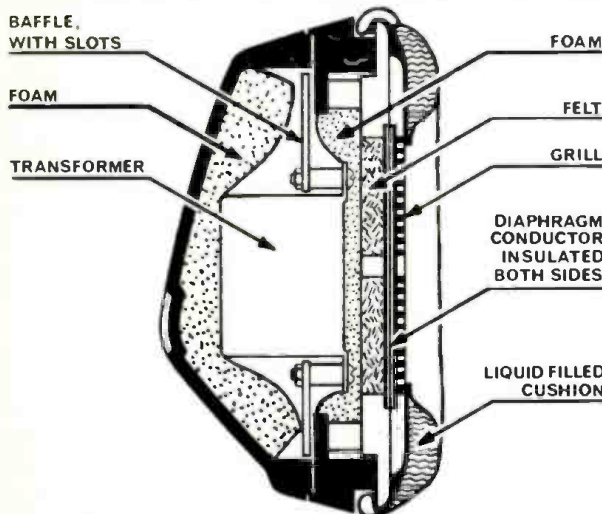

Figure 4. A cross-section of the finished ESP-6 headphone.

Size of the Diaphragm. Certain limits presented themselves in the initial design stages of the model ESP-6 as determined by the finite size of the largest human ears to be accommodated. The mechanical impedance of the device is proportional to the area of diaphragm squared times the acoustical impedance, so it was desirable to have the diaphragm as large as possible. By utilizing all the available area, over five square inches in active area was achieved. Dead capacitance was eliminated by making only the active portion conductive.

Diaphragm Spacing. To make the diaphragm stable, the ratio of diaphragm diameter-to-gap size should be 100:1. This calls for a gap on the order of 25 mils. With a highly-compliant membrane, proper stability would ordinarily demand a voltage gradient across this gap of 70-volts-per-mil minimum.

This would require 1750-volts of polarizing potential, a value calling for a high step-up ratio in the coupling transformer for relatively low source voltages. Choosing 1:60 as a practical ratio, 3 volts at the input would deliver 180 volts on the secondary. With a voltage tripler this delivered in excess of 500 volts. Practical tests disclosed that increments of 100 volts over this amount were yielding less than 1 dB increase in sensitivity, and getting progressively smaller. At less than 500 volts and decreasing in 50-volt steps, the increments became progressively larger; the difference between 150 and 200 volts being 4 dB. This would be a deficient voltage gradient to attain stability under all conditions, except that simply increasing diaphragm stiffness restored stability with wide safety margins.

EXTENDING AND FLATTENING RESPONSE

For frequencies lower than the system resonance of 1500 Hz, a flat frequency response for the sound pressure is expected as long as the ESP-6 radiates into the sealed volume of the ear cavity. This is true because the dimensions are small compared to the wavelength. The rise in the output at resonance responds to the classical method of smoothing the response by the insertion of acoustic resistance behind the diaphragm. The handiest form of this resistance is either felt or polyurethane foam.

Unfortunately, the manufacturers of these products do not consider a rating in acoustical ohms as a necessary specification, and considerable experimentation was necessary to find the final combination of these two that yielded the best results.

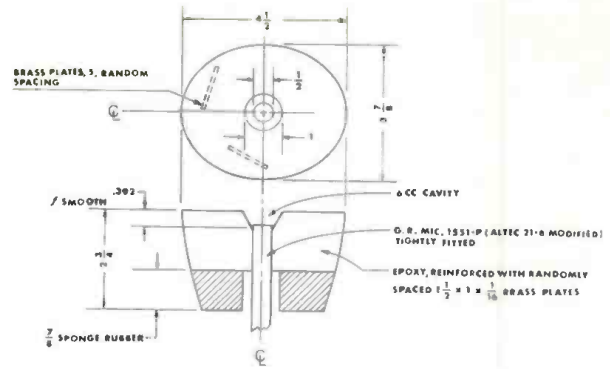

Figure 6. A mechanical coupler as modified for wide-range measurements of circumaural headphones.

FIGURE 3 graphically shows the effect of the application of the acoustic resistance. Care was exercised to preclude over-damping. Several dips and reinforcements were present after assembly into the cups but these responded to treatment with a slotted baffle. One severe out-of-phase reflection from the back of the cup disappeared with the insertion of a one-half inch polyurethane sponge (FIGURE 4).

The struggle for flat response in the last octave above 8 kHz was hampered by the discouraging lack of any standard for measurement which showed correlation with what the ear actually hears.

A direct approach seemed in order to determine the general response of the coupler. To establish the ESP-6 response, comparisons were made with 30 individuals. First, the Acoustech Model X wide-range electrostatic loudspeaker system was used as a standard, and direct correlations established through Cinema graphic equalizers Model 7080A to match the headphone response to the speaker system. Changes were then made in the damping materials on the ESP to match efficiencies in the one-octave bands covered by the equalizers in the high range. White noise as well as transient material was employed in these tests.

It soon became evident that the shunt capacitance of the ear to diaphragm volume required reduction. The diaphragm was then placed well forward in the assembly, and even the small recesses to the ear-side electrode reduced by the application of plastic grills. At 13 kHz a sharp cut-off was circumvented by resonating the transformer leakage inductance

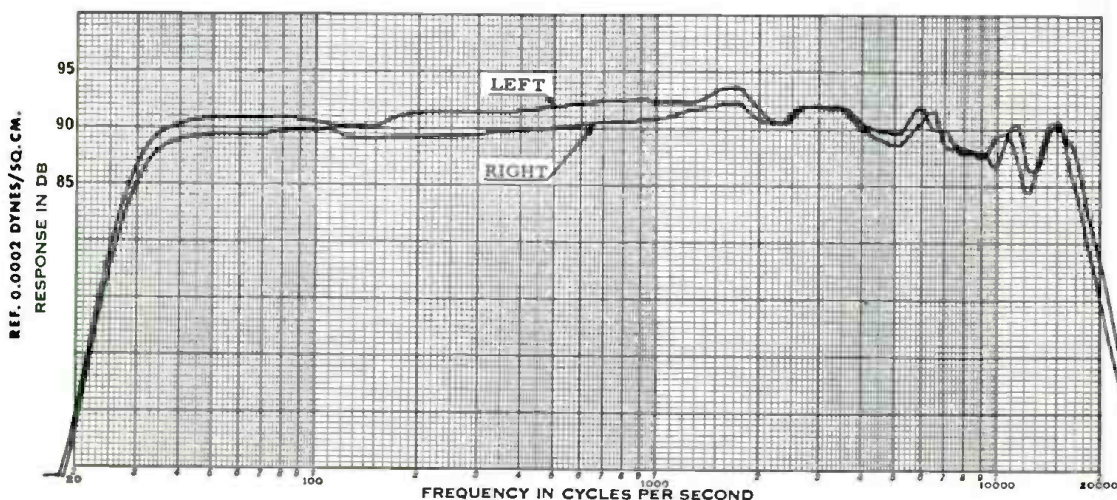

Figure 7. A machine-run response curve of the model ESP-6.

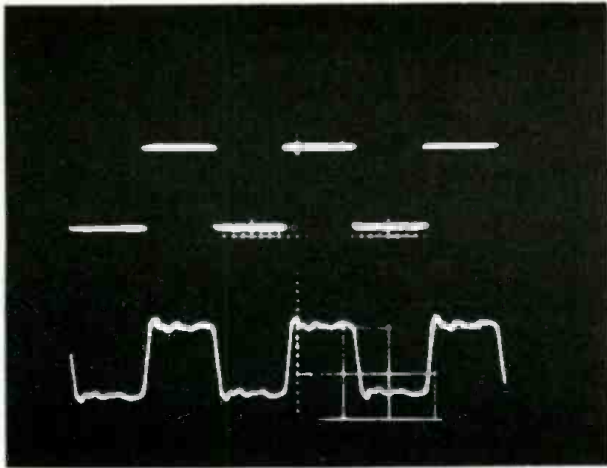

Figure 8. Response to 400 Hz square waves. The upper trace is input, the lower trace the ESP-6.

with the element input capacitance to restore level.

Finally, the coupler was modified, and, in fact, reconstructed to the dimensions shown in FIGURE 6. This delivered a final response curve for the ESP-6 as shown in FIGURE 7.

COUPLING TO AMPLIFIERS

It would seem that the necessary addition of diaphragm stiffness, as described earlier, would decrease efficiency, and it does. However, the added stiffness increases the natural resonance of the system to the region of 1500 Hz. below which the entire system is pressure controlled for virtually flat response.

For practical reasons, the efficiency is well lost. It is present practice to connect headphones to the output of power amplifiers, rather than to employ them at line level. In the first place it is probably only the telephone company who is interested in using this level; broadcast and recording consoles use amplifiers of at least several watts output to bridge the output bus in order not to disturb the line impedance. When higher-wattage monitoring amplifiers are employed, the added gain with ordinary headphones requires severe output attenuation or the system noise will predominate over the signal. This is especially true in home music systems, where we find the amplifier output connected to the front panel phone jacks through series resistances varying from 50 to 250 ohms.

On conventional headphones this frequency response de-



Figure 9. The ESP-6 electrostatic headphone.

grading mismatch is of little consequence, for the narrower passband in the middle of the spectrum is hardly affected. On the ESP-6, however, 100 ohms in series with amplifier output terminals reduces 30 Hz and 12 kHz response by 5 dB.

In its final form the ESP-6 connects without series resistance to the speaker output terminals of almost all amplifiers, and operates with 3-volts of signal from an 8-ohm source (1 watt approx.) to deliver 90 dB of sound pressure level referred to 0.0002 dynes/cm². This is 10th-row volume for a comprehensive 75-piece orchestra playing loud passages.

The power handling ability of the ESP-6 on transients is somewhat dependent on the average energy distribution in music. At 40 Hz the wave form begins to suffer at 9 volts (10 watts) as governed by core saturation of the small coupling transformer. At 1000 Hz the ESP-6 sustains 20 volts (50 watts) but at 21 volts the power-supply components fail, principally the rectifier diodes. At very high frequencies inordinately high voltage punctures the diaphragms, but since less than 3 per cent of the energy content in music lies above 3 kHz, little likelihood of failure exists well beyond any tolerable level.

HOW THE ESP-6 SOUNDS TO THE EAR

As expected from the response curve of FIGURE 7, the reaction to the sound of the ESP-6 was immediate and vivid; the listening character appeared smooth, with relative freedom from fatigue. The subjective effect was even better than the response curve indicated, for some of the hills and valleys in the curve are caused by the measuring equipment, and perhaps some that do exist in the ESP-6 might be offset by resonances in the ear itself.

Square-wave measurements were attended with high interest, for speakers and headphones are notorious for their inability to reproduce them. The results are shown in FIGURE 8. In spite of the small size of the transformer, and the fact that it operates in virtually an unloaded condition, the resemblance to the input square wave is unmistakable.

CONCLUSION

This adventure in headphone design was exciting and rewarding. The usual five octave range was extended to almost nine octaves. While 10 octaves was the goal, the actual range achieved was wider than that of any speaker system yet encountered. The self-energizing circuit performed well. The transient response exceeded that of the best speakers by good measure, while the smoothness of the frequency response and collateral freedom from distortion, confirmed by square-wave measurements, gave a satisfying, fatigue-free quality to the signal hitherto not experienced.

ACKNOWLEDGMENTS

The concept of self-energizing the ESP-6 was originated by Martin Lange, Jr., vice president of Koss Electronics, Inc. Without the incorporation of this principle, the phones stood little likelihood of commercial success. Special recognition is accorded Joseph J. Chladil, whose mechanical skill and painstaking care in fabricating more than thirty successive prototypes insured meaningful evaluations of progressive changes. Full credit is due John P. Sorensen for refining the polarizing system and assisting in charting more than five-hundred frequency response curves. The functional and pleasing styling was executed ably by Joseph C. Besasie. Personal thanks are given to Robert F. Mauger for his services in checking the mathematics, and for his fine assistance in making more readable the involved passages in this manuscript.

36TH AUDIO ENGINEERING SOCIETY CONVENTION AND EXHIBITION

PROFESSIONAL AUDIO EQUIPMENT
FOR STUDIO AND LABORATORY
APRIL 28/MAY 1

AT THE HOLLYWOOD ROOSEVELT HOTEL
LOS ANGELES, CALIFORNIA

IMPORTANT PAPERS will be presented on: Acoustics and Hearing • Amplifiers • Audio Systems and Broadcasting • Disc Recording • Instrumentation • Music and Speech • Noise • Signal Processing • Sound Reinforcement • Tape Recording • Transducers

TECHNICAL SESSIONS: Monday through Thursday morning, afternoon, and evening at 9:30, 1:30, and 7:30 except Wednesday 9:30 and 1:30 only.

AWARDS BANQUET: Wednesday, April 30 at 7:00 p.m.

EQUIPMENT EXHIBITION: Monday through Thursday; Monday and Tuesday, 1:00 p.m.—9:00 p.m.; Wednesday 1:00 p.m. to 5:00 p.m. and Thursday 1:00 p.m. to 5:00 p.m.

Convention Program Banquet Ticket Information available from

AUDIO ENGINEERING SOCIETY, INC., Dept. 34
Room 428, The Lincoln Building, 60 East 42nd Street
New York, New York 10017 (212-661-8528)





An Eight-Foot Board

CHARLES E. WIEGAND, JR.

The December *db* cover pictured a huge console that we had photographed at last year's New York AES Convention. The author describes the special need that led to the design as well as the function of the console's componentry.

NO EXPLANATION of the purpose of eight feet of mixing console board can be offered without first providing some information about the studio for which it was intended. The studio is unique in many ways, the first of which is that it is housed in a plush residential setting in an exclusive hilltop community in New Jersey.

The studio complex consists of two recording studio rooms and one common control room. One studio room measuring 34 by 16 feet is known as the music conservatory studio. It is luxuriously appointed with wall-to-wall carpeting, heavy window draperies and an acoustic tile ceiling. It houses two Steinway concert-grand pianos, a German harpsichord, and a two-manual three-tone cabinet Allen electronic organ. The other studio measuring 20 by 40 feet is known as the pop music studio. It is conservatively appointed and equipped with two more Steinway pianos, one a honky-tonk type, a Hammond organ with Leslie tone cabinet, a stand-up organ and several electric-guitar amplifier units. The central control room measuring 16-feet square houses a console mounted Scully twelve track 1-inch master tape recorder with an optional eight track 1-inch plug-in head assembly; a console mounted Scully four track 1/2-inch master recorder with adjustable tape guides and an optional full-track monophonic 1/4-inch plug-in head assembly; and a Scully two track 1/4-inch stereo recorder with sync. on one track. This is in addition to a record playback turntable and stereo preamplifier, as well as four Altec A-7-500W-L Magnificent speaker systems.

THE CONSOLE

The eight-foot console is divided into two major operational sections. On the left is the input and multi-track record sec-

tion, and on the right is the remix and re-record section (FIGURE 1). The input section consists of 18 W.A.L. model 100 input modules above which are 18 W.A.L. model 212 illuminated output selector switch modules (FIGURE 2). This set of 18 input and switch modules allows eighteen microphone or line inputs to be recorded on any one or several of the twelve tracks. Eighteen inputs are necessary to allow simultaneous recording of various instruments in both studios during a single session.

THE INPUT MODULE

The W.A.L. model 100 input/remix module contains the following circuit functions and front-panel mounted controls.

1. A low noise microphone preamplifier with low-impedance balanced input.
2. A straight line vertical slide attenuator for microphone or line mixing.
3. A line or microphone input selector switch with a line position and four microphone positions for 0, 15, 30, and 45 dB of attenuation to prevent overload on signals from very loud sound sources or to act as an extra line input to allow input switching between the output of two line-level sources such as console and recorder outputs.
4. A built in no-loss program equalizer with a high and low frequency boost and cut control. Low frequencies are selectable at 40 or 100 Hz., while high and mic range frequencies are 1.5, 3, 5, and 10 kHz. Both high-and low-boost controls have steps at plus and minus 0, 2, 4, 6, 9, and 12 dB of attenuation.
5. Echo send level control and echo pre/post selector switch allows setting echo or reverb level plus a choice of taking the echo signal before or after the vertical slide mixer and the built-in program equalizer.
6. Built in echo and direct solid state line amplifiers to feed outputs to selector switch panels.
7. Cue or audition switch and control which switches the control-room speakers from normal program material to the

Charles E. Wiegand is president of Wiegand Audio Laboratories.

output of the cue bus which is fed from the cue level control and switch on each input/remix module in a console system. This permits sample mixes on the cue bus without disturbing the recording signal controls.

8. External special-effects insertion switch allows switching in an external special-effects unit such as a graphic equalizer, a sharp cutoff filter, a large program equalizer, or a tape-delay echo system into any input/remix module without the use of a patch panel. A red lamp indicates when the special effects equipment is already in use with another module in the console.

9. An instrument panel mounted v.u. meter in a console system can be switched between the two line inputs of a input/remix module being used in a separate remix section of a console system to allow a-b switching.

THE SWITCH MODULE

The W.A.L. model 212 twelve-position illuminated switch module contains twelve push-to-lock/push-to-release illuminated color-coded engraved push-button switches. When a switch push-button is illuminated it means that both the direct-and echo-send signals from the model 100 input module just below the switch module is being sent to the track whose number is illuminated. More than one track may receive the signals from a single input module. In addition, several input modules may send their signals to one output track without any unwanted crosstalk. Both flexible and rigid printed-circuit wiring is used within the switch module to eliminate hand-wiring errors in assembly. The rigid printed-circuit board terminates the 28 conductors in a printed-circuit board connector mounted in the console cabinet module connector tray.

MASTER RECORD SECTION

Just to the right of the 18 input modules are 12 W.A.L. model 300 master record/reverb modules as shown in FIGURE 3. This type module fills the gap left in many other console systems by providing in a single front-panel mounted package, those functions that are required for each separate track of each recorder in a studio. It substitutes for several separate modules plus providing some functions not found at all in other console systems.

The W.A.L. model 300 contains a master-record vertical-slide mixer; a master echo-send level control; a master echo-send edgewise-mounted vertical v.u. meter; two echo-return controls to allow mixing the internal reverb and the external echo signals; two 22-input active computer-type combining networks (one for direct inputs and one for echo inputs); a solid-state current feedback amplifier and preamplifier for use with an externally mounted Hammond organ reverb spring-delay pan; a balanced line-level output amplifier; an echo-send line amplifier; and a reed relay to allow placing slating information on a record track by the push of a button on the W.A.L. model 400 monitor/playback control module which contains the slating/talkback microphone preamplifier. These twelve modules provide record level and echo control of the signals going to each of the twelve tracks. Twelve Hammond organ-type reverb spring pans can be mounted within or external to the console cabinet, thereby providing a separate built-in reverb system on each of the twelve tracks. In addition echo send and return circuits are provided to use with an E.M.T. or live echo chamber on any one or all of the twelve output tracks.

Mixing controls are provided on each track to allow any combination of the two types of reverb to be placed on each



Figure 1. Over-all view of the complete console cabinet.

track. Having a built-in reverb on each track of each recorder in the studio allows reverb to be added either while recording on each track initially or during the remix session transfer to stereo or mono submaster tapes. The built-in 22 input direct and reverb analog-computer type active combining networks allow up to 22 input signals to be mixed together without additional of noise, distortion, or unwanted crosstalk on other tracks. These twelve master record/reverb modules could also be used with a sixteen-track 2-inch master recorder by limiting recording to any twelve tracks during any one take. For example modules one through four could also send signals to tracks thirteen through sixteen.

MULTI-TRACK REMOTE CONTROL FACILITIES

To the left, right, and immediately above the twelve master record modules are master sync. and directional remote controls for two multi-track master recorders, one sixteen-track 2-inch machine and one twelve-track 1-inch machine. The sixteen track recorder is planned to be added later. These built-in remote controls greatly simplify studio operations. They employ the same type high-quality illuminated color coded, engraved, push button switches as the switch modules.

PERIPHERAL EQUIPMENT

Above the twelve master record modules is located an area where optional accessory equipment may be mounted. In this



Figure 2. Side view of eighteen input modules (left) and twelve master record/reverb modules (right) surrounded by remote controls and limiters.

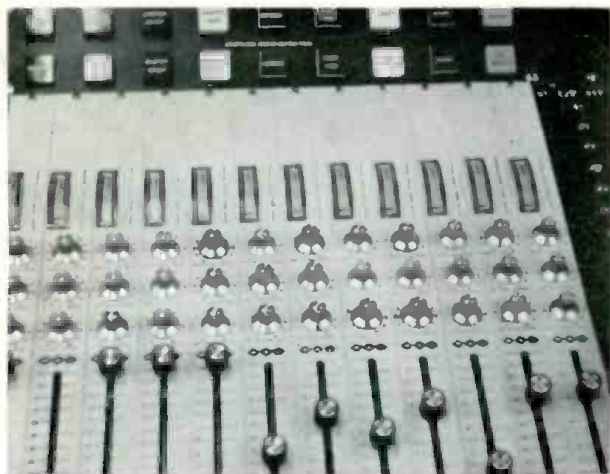

Figure 3. A head-on view of twelve master record/reverb modules below master sync. and directional tape-recorder remote controls for twelve- and sixteen-track recorders in the system.

particular console, two Universal Audio model 1176 solid-state limiter/compressor amplifiers are mounted. Through the use of a patch-panel and/or the special-effects switching system, these limiters may be placed in cascade with any input, output, or remix signal within the console. In addition, access to the inputs and outputs of these limiters and the built-in graphic equalizer appear on the input/output panel located on the rear of the console cabinet. Above both the eighteen input modules and the twelve record modules mounted on the vertical instrument panel are twelve $3\frac{1}{2}$ inch A.P.I. model 361 illuminated v.u. meters that monitor twelve-track record and playback levels.

SIXTEEN TRACK REMIX SECTION

Just right of the twelve master record/reverb modules is a sixteen-position separate remix section. Sixteen more W.A.L. Model 100 input/remix modules are used here as remix modules. The internal printed-circuit boards are restrapped so that the -45 dB microphone-attenuator position of the input selector switch is a second line-input position. Line position *one* of the first twelve remix modules is connected to the twelve outputs of the twelve-track recorder. Line position *one* of the last four remix modules is connected to the four outputs of the four-track recorder. Line position *two* of all sixteen remix modules are connected to the output of the proposed new sixteen-track recorder. The input selector switches of these remix modules also control the signals driving the twelve instrument-panel mounted v.u. meters mentioned before. The meters are connected to the first twelve modules only.

In smaller consoles not equipped with recorders using sync./master remote control, the two-line-position input selector switch allows console switching of remix monitor facilities from the output of the console (A signal) to the output of the recorder (B signal). Just above these sixteen remix modules are sixteen model 204 illuminated four-position output selector switch modules. These sixteen modules allow each of the sixteen remix modules to send its direct and echo output signals to any one or more output tracks by just depressing a button until it is illuminated.

The four output tracks serve two purposes. First, they allow remixing or direct live recording on the four-track $\frac{1}{2}$ master recorder. Second, when remixing down to stereo and/or mono output *one* and *two* are left and right stereo signals

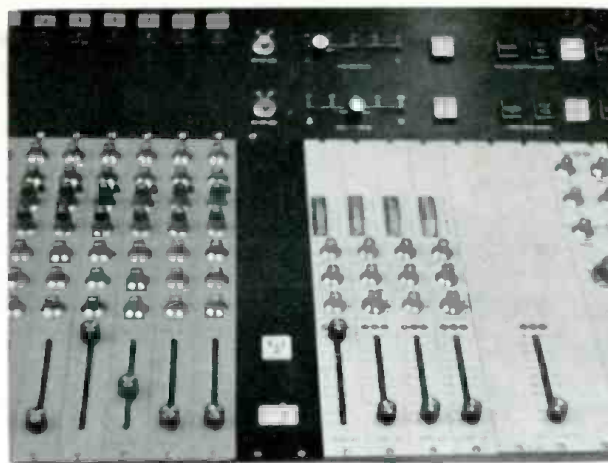

Figure 4. A head-on view of right third of remix section with four master record/reverb modules and model 400 monitor/playback control module.

while output *three* is the mono signal. To center channel any input track one merely depresses both the *one* and the *two* buttons above that track. Outputs *three* and *four* also serve to feed two separate stereo pan pots during a stereo mixdown. These two phantom channels may be used to pan two different soloists between the left and right stereo channels while instrumental tracks are placed either left, right, or center by just depressing the appropriate illuminated push button.

FINAL OUTPUT AND MONITOR SECTION

Next to the sixteen remix modules are four more model 300 master record/reverb modules (FIGURE 4). These modules control the record level and amount of echo and reverb going to the four-track, two-track, and/or mono recorder in the system. Just to the right of these four modules is a stereo master slide attenuator panel which controls the level of both tracks of the two-track recorder together to allow stereo fade outs. The last module on the right end of the console is the W.A.L. model 400 monitor/playback control module. This module contains the following circuit functions and front-panel-mounted controls:

1. Record-play input selector switch to allow listening to the output from the console to the two-track or four-track recorder (Record position) or the playback from the two- or four-track recorders (playback position).

2. Control room monitor function selector switch and stereo listening level control allows setting stereo listening level in control room and selection of listening to mono, stereo, four-track, all-left, or all-right signals.

3. Studio playback function selector switch and stereo listening level control permits same control functions as in number 2 above for control room.

4. Control room speaker select or switch allows switching from large speaker system to small 4-inch transistor-radio type speakers built into the mixing console cabinet. This gives comparison of sound as heard by consumer on transistor and car radios.

5. Studio speaker on-off switch allows turning off studio speaker system while recording and listening on earphones for track sync. work. This switch is overridden by talkback relays during talkback operation.

6. Stereophone jack for checking listening level on studio headphones from control-room location.

7. Built-in talkback relay to allow switching from normal program material to talkback microphone amplifier output when talkback or slating push button is depressed.

8. Talkback microphone preamplifier, input transformer, and input selector relay allows use of two different talkback microphones for engineer and producer or A & R man locations at the console.

9. Cue/audition bus input active combining network and amplifier with cue relay to allow any one of 32 cue signals to be heard on control room speakers while listening to normal program sources in studio.

The built-in cue/audition system permits sample mixes of microphone or line-input signals during or before a live recording session without having to disturb any of the level, equalization or reverb settings already established. This is in addition to permitting the recording engineer to check each input signal separately to determine if the right microphone is in the correct position and with the correct pickup pattern, to determine if the input overload attenuator is required, and to determine the correct setting of the program equalizer and any special-effects unit which may be in the circuit at the time. This cue system should not be confused with the type of cue system used to provide signals to stereophones during overdubbing. That function is handled by the controls on the W.A.L. model 400 monitor/playback control module being fed by the remix monitor section of the console.

In addition to the ones on the model 400 an extra set of talkback and slating push-to-talk buttons are located on the other end of the console control surface. On the spacer panel to the right of the Model 400 control module is a test-tone switch which places a test signal on each track of each recorder in the console system for level calibration and recorder alignment.

Above the four final master record/reverb modules, the stereo master slide attenuator panel, and the monitor/playback control module is mounted a panel containing the two slide-type stereo pan pots and two pan pot signal on-off switches, two sets of illuminated tape recorder remote control push buttons for the two-track, four-track, and mono recorders, and a patch panel to allow pre-programming and assigning special-effects devices to certain input or remix modules in the console. This is to supplement the one-per-console special-effects push-button select or-switch panel, this is mounted just above on the instrument panel to the left of the built-in graphic equalizer.

As just mentioned, the instrument panel mounted graphic equalizer can be switched into any input or remix module circuit by use of the special-effects selector-switch panel and the individual special-effects in-out switch on each input or remix module in the console. In addition the graphic equalizer can be used in other parts of the studio by use of the rear input/output connector panel and the normalizing contacts on the special-effects selector switch. There are five switch-selectable special effects. These are the graphic equalizer, one of the built-in limiters, an external sharp-cut off filter, a large external program equalizer, and psychedelic tape-delay echo system.

The special-effects input and output of each input or remix module in the console is normalized through a set of jacks on the patch panel to the common special-effects input and output terminals on the five-position special-effects push-button selector-switch panel. On the instrument panel just left of the special-effects switch panel are four 5-inch A.P.I. model 561 illuminated v.u. meters. These are switched by the model 400 monitor/playback control module between the input (other A signal) and the output from (the B signal) the

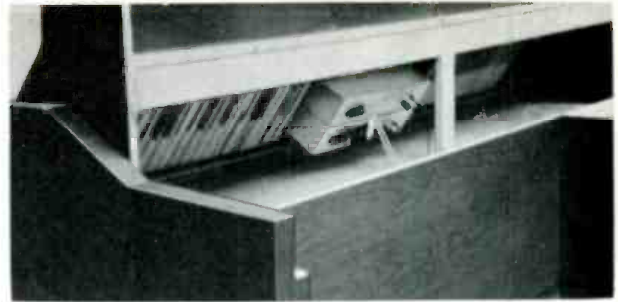

Figure 5. A view of console cabinet in uplifted position.

two-and four-track recorders. This completes the description of the control surface of the eight-foot console.

IN BACK

On the rear of the console cabinet is an eight-foot long input/output connector panel. All microphone inputs and line inputs and outputs for the console are terminated here with Cannon-type connectors and speaker and headphone outputs are terminated with phone jacks. Beneath the right end of the console cabinet is a pedestal which houses eight 120-watt solid-state power amplifiers, W.A.L. model 500, in addition to a solid state regulated power supply for the console system. The console cabinet is supplied with a padded arm rest across the entire eight-foot front edge. The cabinet is finished in gun stock walnut General Electric Textalite which is the same material used on the Scully tape recorder cabinets.

FIGURE 5 shows how the console cabinet control surface lifts up to allow future additions to the master cable harness and to provide wiring to any modules that may be plugged in during a system expansion. It should be noted that all the electronics in the console are located in control-panel mounted plug-in/plug-out modules. The console cabinet when emptied only contains the master wiring harness, the instrument panel, and some peripheral items.

PURPOSE OF SEPARATE REMIX SECTION

The separate remix section of the console becomes a very sophisticated monitor mixer during a live recording session. This section combined with the input section permits the recording engineer to place reverb and equalization on individual tracks of the multi-track master recorder or to add it with the monitor remix section—thereby keeping the original tracks dry. The record producer and musicians will hear the same sound effect whether equalization and reverb is added before or after the multi-track master recorder. However, if it is added later with the separate remix section, it can always be changed during a subsequent remix session. If several microphones are to be placed on one track during initial live recording, and each microphone requires a different amount of reverb and echo, than echo and reverb must be placed on the individual track of the multi-track master tape. Placing the balance of the echo and reverb on the tracks while remixing eliminates the need for numbers of E.M.T. or live echo chambers since one stereo E.M.T. can be used to place echo in various amounts on all sixteen tracks during a remix session. This separate remix section makes it possible for the record producer to experiment with various mixes, amounts of equalization, and reverb at the time of a live recording and playback session. So he will know what to expect when he comes back later to remix. In fact, he may discover that the original mixing scheme created an unmixable master. He can now make changes during the live session, rather than redoing the session later at an attendant great expense.

An Electronic-Music Sequencer

ROBERT C. EHLE

In November of last year, the author described an over-all design for an electronic-music synthesizer. In this installment he writes about one of the prime components as he details the design of a sequencer for the automated processing of sound.

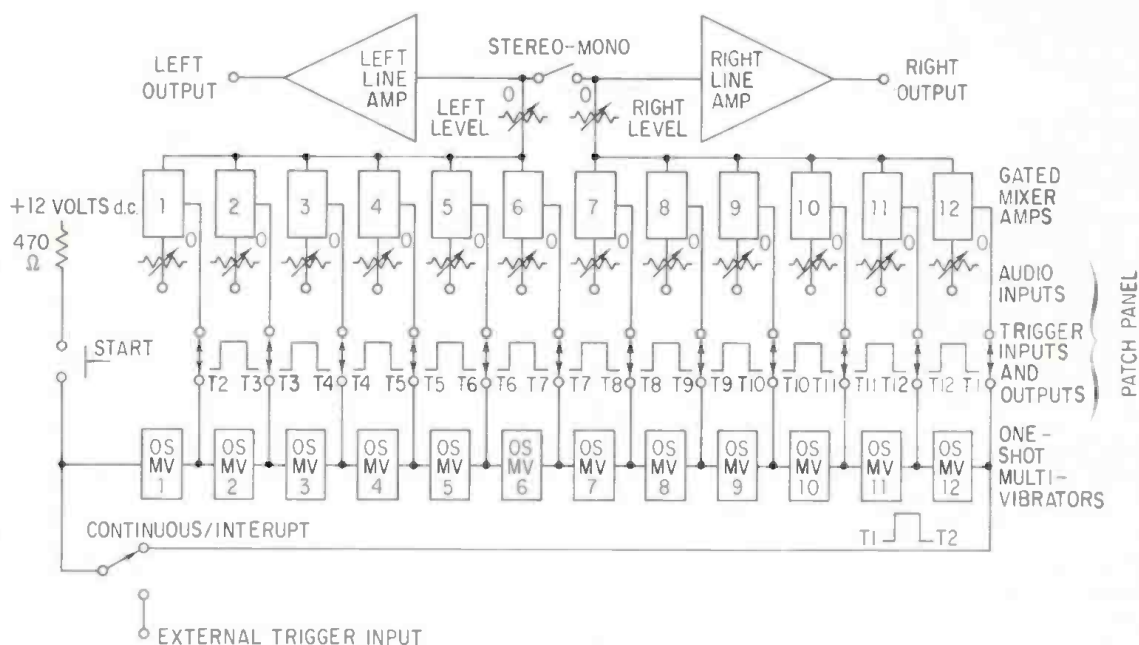

Figure 1. Block diagram of the sequencer described in the text.

Robert C. Ehle is a consultant and teacher of electronic music. He holds a master of music degree in composition and has taken advanced courses in mathematics, electronics, and computer-systems technology.

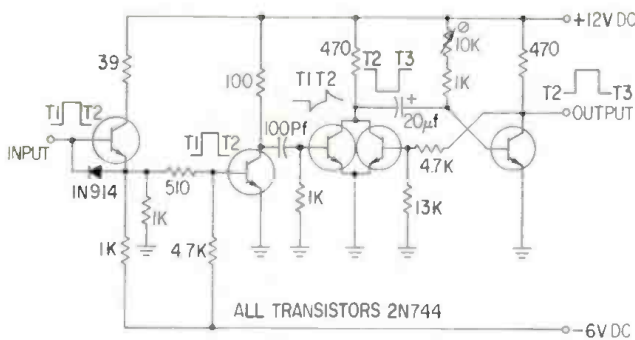

Figure 2. One-shot multivibrator as used in the sequencing mixer.

IN THE QUEST for the means to re-create all imaginable sounds, electronic music has made considerable strides in synthesizing individual sounds, tones, or musical events.

When it comes to assembling these into larger musical structures only two techniques have been found entirely adequate in terms of results. These are the assembly of musical structures by means of splicing recorded tape, and the method of composition with the digital computer. Each has serious drawbacks in utility. The drawbacks are obvious; splicing is extremely time consuming, while digital computers large enough to generate music are extremely expensive.

Recently, attention has been turned to the technique of using programming devices with the analog sound synthesizer.¹ Three basic levels of programming have been delineated: These are control with punched tape or similar mechanical recordings, control with electronic sequencers, and control by small digital computers. All three methods have desirable features. The punched-tape method provides a permanent record, the sequencer is easily alterable and not expensive, while the small digital computer provides fairly elaborate program control at lower cost than the method of sound generation with large digital computers.

In the area of all-electronic sequencers many different possibilities-for-design exist. The simplest type is a ring generator where each output provides a pulse to some triggered sound generating or processing device. A more elaborate device employs a ring of one-shot multivibrators in place of the ring generator. This technique allows the individual control of the duration of each output pulse. If each output pulse triggers an envelope generator, many individually timed events may be programmed into the sequencer and automatically generated. The number of different events depends on the number of stages of one-shots included in the unit. The envelope generator outputs do not need to be used to generate actual amplitude envelopes but may be employed to generate frequency envelopes by using the output voltage to control a voltage-controlled oscillator. A spectrum envelope may be generated in like fashion by controlling a voltage-controlled filter. Of course, the unit containing many stages

of such sequencing involves a considerable amount of circuitry.

The sequencer built by the author and described in this article has the following specifications: Twelve one-shot multivibrators are arranged in a ring, with provision made for breaking the ring and inserting an external trigger. This sequential-pulse generator (it generates twelve sequential pulses) is used to trigger twelve stages of a sequencing mixer. The inter-connections are made by means of a patch panel, thus allowing the user to rearrange the patching to suit his needs. Each stage of the mixer contains an individual level adjustment, and the mixer is divided into two sets of six outputs for stereo division of input materials into two channels. A stereo-mono switch combines the two sets of six outputs before passing through two line amplifiers. Thus for monophonic operation, six inputs operate from one master gain control and six from the other, but all twelve inputs appear equally in the two outputs.

The accompanying circuit diagrams illustrate the block diagram of the sequencing mixer (FIGURE 1), the schematic diagram of the one-shot multivibrator (FIGURE 2), the schematic of one gated-mixer stage (FIGURE 3), and the schematic of one line amplifier (FIGURE 4). In order to construct the entire mixer one must build twelve one-shot multivibrators, twelve mixer amps. and two line amps. and then interconnect

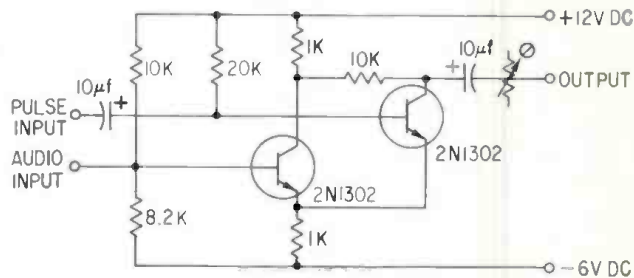

Figure 3. The gated mixer amplifier as used in the sequencing mixer.

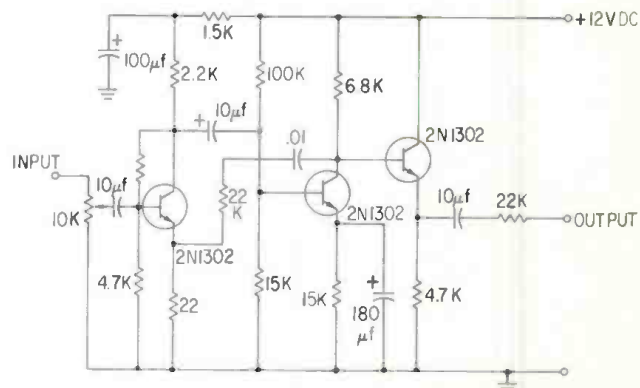

Figure 4. The line amplifier used in the sequencing mixer.

them in the configuration shown by the block diagram. They may be built on vector board which is then mounted to a patch panel to provide a complete, mountable unit. A convenient procedure is to use a 19-inch rack-mount patch panel and mount the circuitry behind it on stand-offs.

FIGURE 5 and 6 give circuits of plus twelve- and minus six-volt power supplies which may be employed to power the sequencing mixer. These power supplies have considerable reserve for powering other components if desired as well. The two power supplies may be interconnected with a common-ground terminal and a common power switch and a.c. line plug.

PERFORMANCE AND EXPANSION

As it stands now the sequencer is particularly useful for certain types of work. It is ideal for synthesizing rapid pointillistic passages of the sort so popular with *avant-garde* composers today. The potentiometer shown on the schematic of the one-shot multivibrator allows the pulse duration to be varied from approximately 200 to 500 milliseconds. Pulses of these durations are used to gate audio signals in the gated mixer. In this way the sequence of events is set in this time order. Thus, if manually-controlled varying-audio signals or frequency-modulated signals are presented to the mixer, the result is that these varying audio frequencies are chopped into interspersed segments. Therefore, there is a great variety of movement as well as greater clarity than would result if the several audio signals were mixed in conventional additive fashion.

FIGURE 7 is an illustration of the operation of the sequencing mixer where the four different crosshatched patterns represent four varying audio signals. The four pulse trains under them represent the pulses used to gate the mixer (in this case four of the twelve outputs). The bottom line represents the composite output of the sequencing mixer.

As was mentioned earlier, the next step in expanding the

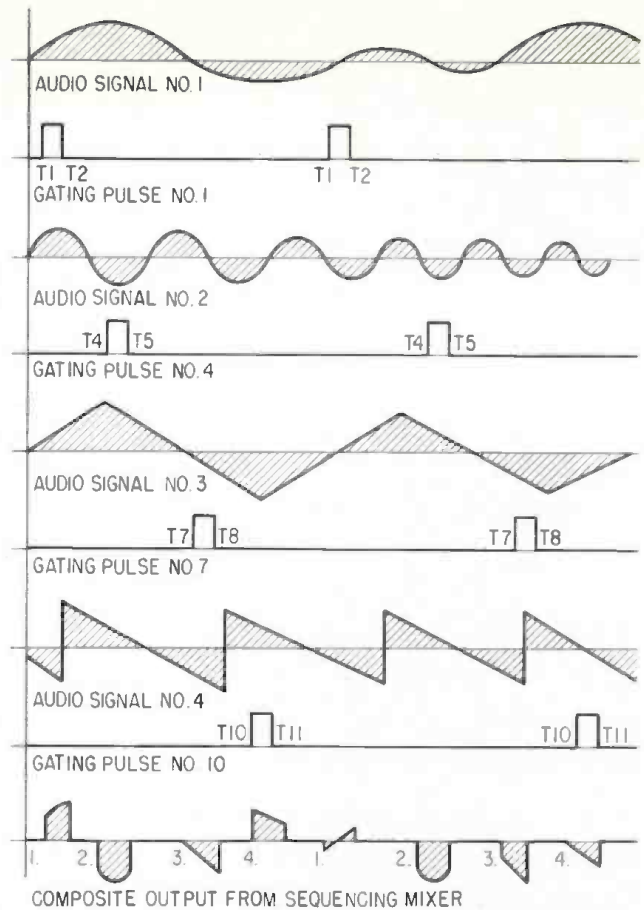

Figure 7. This series shows several typical timing diagrams of the sequencing mixer described in the text.

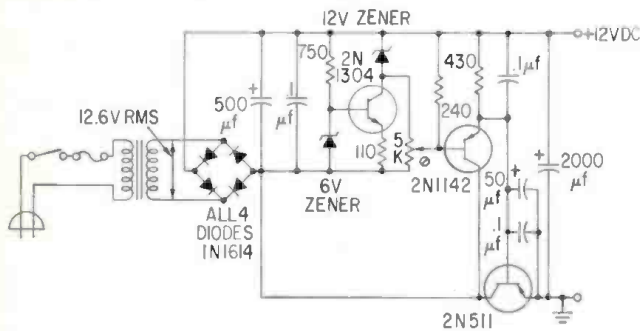

Figure 5. A plus twelve-volt regulated power supply that may be used to power the sequencing mixer.

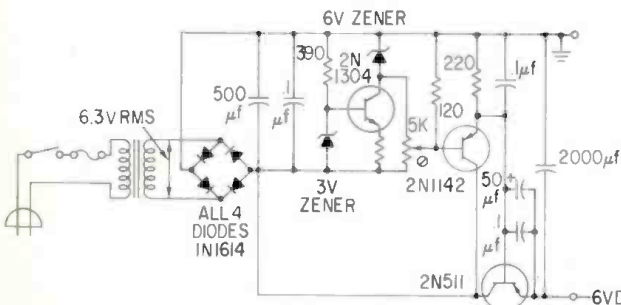

Figure 6. Similar in function to the power supply in Figure 5, this circuit produces a regulated minus six volts.

versatility of the sequencer is to add a number of triggered envelope generators such as the R. A. Moog Model 911 envelope generator. Ideally, twelve such envelope generators may be used, one per channel from the sequencer. Thus twelve individually controlled, overlapping envelopes would result which could be used to control any voltage-controlled devices.

Several variations in performance are made possible by the inclusion of the continuous/interrupt switch and the external trigger input. If the switch is thrown to interrupt and an external trigger is provided once only, a sequence of twelve output pulses is generated. The sequence of output pulses is repeated once per input pulse.

The start button is necessary to insert a pulse into the ring generator. If it is pressed more than once it is possible to have several pulses circulating in the ring simultaneously, thus generating a much more complicated sound output.

It should be realized that the sequencer must be used with other equipment. It is very conveniently used with voltage-controlled oscillators and, in any case, requires several independent sound sources to realize its greatest potential. The author has constructed several voltage-controlled oscillators with linear controllers for each. When these are used as inputs to the sequencer each input is easily controllable over a wide frequency range. In this way a performer can have virtually complete control over very pointillistic material.

¹Various authors. "Symposium on Programmed Control", *Electronic Music Review*, Vol. 1, No. 1.

Theory and Practice

NORMAN H. CROWHURST

• Continuing now from last month on the idea of making an electronic sequencer that will play any predetermined tune any time the button that starts it is pressed. . .

I'd already found a latching circuit that worked for another job, so I applied that here. The 2N323 and 2N388 at the left hand end of FIGURE 1 completed a very workable circuit. Normally neither of these transistors conducts, but the 50 mF capacitor (first one in the line) is charged, ready to go. Because no current continues to flow, the 2N388 is *off* and the 2.2k resistor from base to emitter is needed to keep it *off*.

The same with the 2N323, its base is connected through a 10k resistor to supply to the oscillator collectors, which is normally *off* at supply-plus potential.

When the button is pressed, it initiates conduction in the 2N388 as well as biasing the first stage to cut-off by connecting the negative side of the first capacitor to supply plus. This passes

supply to the whole circuit (through the 2N388) including the oscillator, which is allowed to come on because the first emitter follower is conducting. This holds the 2N323 *on* through the 10k base resistor.

The circuit is held *on* by this means, regardless of what happens at the button, until the sequence is finished, which shuts off the voltage to the oscillator and thus cuts off the 2N323 and through it the 2N388. However, the 2N388 doesn't shut off suddenly, because first it has to charge the first capacitor, ready for the next sequence to be started.

Thus, if the button is held too long, the sequence finishes and cuts off the 2N323, but not the 2N388. When the button is released, nothing happens, the first capacitor starts to charge up, ready to start the next sequence, before the supply to the sequence circuit is cut off. The supply to the oscillator is cut off, because the previous sequence has fin-

ished and cut it off.

When I started this development, I found that a solid pressure, to hold the button until the first one or two tones of the sequence had finished, was needed to make it work properly. So even after I had changed the circuit to include this latching effect, I still tended to hold the button steadily, through force of habit.

However, when once I realized that the first touch of the button was what started things, and that after that I could let go, I changed my manner to just "punching" the button. Altogether, this had been a rather intriguing piece of development. I should add that I had to use 2N395's every place where the base gets positive of emitter, because 2N323's won't take that. But 2N323's have greater gain, where they are used merely in conducting or non-conducting modes, but with no reverse voltage between emitter and base.

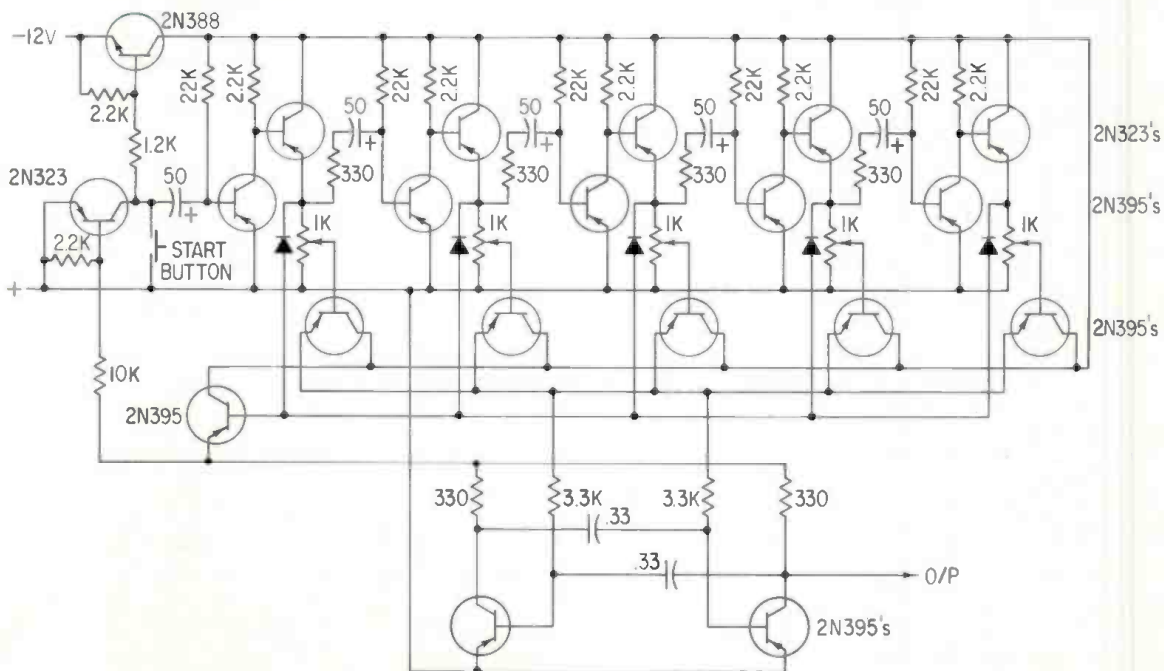

Figure 1. The latching circuit at the left completes a workable circuit.

The db Bookcase

As a service to our readers we are pleased to offer these books from prominent technical publishers. All prices listed are the publishers' net. Shipping charges are included.

Use the coupon at the bottom of the page or give the complete title, author and coupon number. Be sure to indicate quantity on the special instructions line if more than one copy of a title is wanted. Full payment must accompany your order. We cannot ship c.o.d. Checks or money orders should be made payable to Sagamore Publishing Company, Inc. Because of the time required to process orders, allow several weeks for the receipt of books.

Broadcasting

RADIO BROADCASTING

edited by Robert L. Hilliard. Each of the five chapters has been written by a prominent educator with an extensive background of practical experience in commercial and educational broadcasting. The areas covered include: management and programming, operating and studio facilities, producing and directing, writing, performing. For those of you who want to, or must, operate on both sides of the control room, this is virtually required reading. 190 pages, 6 1/4 x 9 1/2; indexed, clothbound.

\$6.95 (\$8.35 in Canada)
Circle 2 on Coupon Below

Reference

New 17th Edition of the famous RADIO HANDBOOK

Tells how to design, build and operate the latest types of amateur transmitters, receivers, transceivers, amplifiers and test equipment. Provides extensive, simplified theory on practically every phase of radio. Broad coverage; all original data, up to date, complete. 847 pages.

\$12.95 (\$15.50 in Canada)
Circle 10 on Coupon Below

How To

PRACTICAL PA GUIDEBOOK: HOW TO INSTALL, OPERATE AND SERVICE PUBLIC ADDRESS SYSTEMS

by Norman H. Crowhurst. 1967. This book gives all the basics needed to become a successful PA operator, in any situation where the reinforcement, relay, or distribution of sound can provide a service. It shows how to properly install, operate and service public address systems. All aspects of the subject, from survey to the selection of appropriate equipment, to installation, to routine operation and the maintenance of a finished system, are covered. Attention is given to solving problems encountered in providing successful service. The book's systematic and practical approach makes it highly useful to radio-TV servicemen, hobbyists, and PA equipment manufacturers. 136 pages, 6 x 9; illus.; softbound.

\$3.95 (\$4.60 in Canada)
Circle 15 on Coupon Below

CLOSED-CIRCUIT TELEVISION HANDBOOK **NEW!**

by Leon Wortman. Gives comprehensive detailed information about the field in an easy-to-understand presentation. It's particularly suited to those who plan to use, install, and service cctv. Covers the subject from the simple single-camera system to the most exotic systems. 288 pages, 5 1/2 x 8 1/2; clothbound.

\$7.95 (\$9.50 in Canada)
Circle 18 on Coupon Below

Electronic Music **NEW!**

ELECTRONIC MUSICAL INSTRUMENTS

by Richard H. Dorf. Now in its third edition and sixth printing since its first appearance in 1954, this is considered the authority on electronic organs. This edition is completely rewritten to explain everything technical about today's organs. The book is of special value to organ designers and service technicians as well as electronics-minded hobbyists and prospective organ purchasers. Of special value are the author's many practical comments and expressions of opinion based on his years of musical, engineering, and management experience with electronic musical instruments. 393 pages; 239 diagrams and photographs.

\$10.00 (\$11.95 in Canada)
Circle 19 on Coupon Below

General Audio

THE TECHNIQUE OF THE SOUND STUDIO

by Alec Nisbett. This is a handbook on radio and recording techniques, but the principles described are equally applicable to film and television sound. It describes how the highest standards may be achieved not only in the elaborately equipped studio but also with simple equipment out on location. 264 pages; 60 diagrams; glossary; indexed; 5 1/2 x 8 1/2; clothbound.

\$10.50 (\$11.95 in Canada)
Circle 1 on Coupon Below

DESIGN OF LOW-NOISE TRANSISTOR INPUT CIRCUITS

by William A. Rheinfelder. 1964. Written for students as well as circuit design engineers interested in low-noise circuit design. Throughout, the book gives a multitude of time-saving graphs and design curves for the practical circuit designer. Simple derivations of all important formulas are also presented to help the reader obtain a deeper insight into the fundamentals of practical low-noise design. 128 pages; 6 x 9; illus.; clothbound.

\$5.50 (\$6.50 in Canada)
Circle 14 on Coupon Below

Electronics and Mathematics

ELECTRONICS MATH SIMPLIFIED

by Alan Andrews. For the engineer, student, or technician who requires a knowledge of mathematics as it pertains to electronics. Covers the subject in a logical, clear, and concise manner, using dozens of examples related specifically to electronics. Particularly suited for use as a textbook in any school or other training program involving the study of electronics, the book has been especially prepared to coincide with studies leading to 2nd- and 1st-class FCC Radiotelephone licenses. (2 vols. in slipcase)

\$7.95 (\$9.95 in Canada)
Circle 11 on Coupon Below

MATHEMATICS FOR ELECTRONICS ENGINEERS & TECHNICIANS

by Norman H. Crowhurst. This book is written to help the advanced technician and the engineer bridge the gap between "book learning" and practical experience. It is not about mathematics but about how to use mathematics in electronics. A unique programmed method shows not only how to apply textbook math towards the solution of any electronics problem but also teaches how to think in the best way for solving them. Much emphasis is placed on correcting misconceptions commonly held by technicians. The book begins with Ohm's and Kirchhoff's laws and goes on to selective networks, properties of coils and transformers, feedback circuits, etc. 256 pages; 5 1/2 x 8 1/2 (hardbound).

\$6.95 (\$8.35 in Canada)
Circle 4 on Coupon Below

Sagamore Publishing Company, Inc.
980 Old Country Road, Plainview, N.Y. 11803

Please send me the books I have circled below. My full remittance in the amount of \$..... is enclosed. N.Y. State residents add 4% sales tax.

1 2 3 4 5 6 7 8 9 10 11 12 13 14 15 16 17 18 19 20 21 22
23 24 25 26 27 28 29 30 31 32 33 34 35 36 37 38 39 40

Name.....

Street Address.....

City.....State.....Zip.....

Special Instructions.....

HANDBOOK OF ELECTRONIC TABLES & FORMULAS, (3rd Edition)

A one-stop source for all charts, tables, formulas, laws, symbols, and standards used in electronics. Devotes complete sections to items of interest to service technicians and to circuit design data. Includes a 8-page, full-color fold-out chart showing latest FCC allocations for the entire frequency spectrum. 232 pages; 5 1/2 x 8 1/2; hardbound.

\$5.50 (\$6.60 in Canada)
Circle 8 on Coupon Below

Test and Maintenance

INTERMODULATION AND HARMONIC DISTORTION HANDBOOK

by Howard M. Tremaine. A complete reference guidebook on audio signal intermodulation and harmonic distortion. 172 pages; 5 1/2 x 8 1/2; softbound.

\$4.25 (\$5.25 in Canada)
Circle 9 on Coupon Below

Circuitry and Components

PASSIVE AUDIO NETWORK DESIGN

by Howard M. Tremaine. A complete and comprehensive guide to the design, construction, and testing of all types of attenuators, equalizers, and wave filters for the practicing audio technician or engineer. This authoritative text is one of the few written on the subject, and requires only nominal mathematical background. Written in easy-to-understand language, the content presents the basic design, construction, and testing considerations without the confusion often associated with passive networks. 288 pages; 5 1/2 x 8 1/2; softbound.

\$5.50 (\$6.45 in Canada)
Circle 5 on Coupon Below

TRANSISTORS FOR AUDIO FREQUENCY (AUDIO-FREQUENCY AMPLIFICATION)

by Guy Fontaine. 1967. This systematic and detailed treatment of the application of transistors in audio-frequency amplifiers shows how the published transistor characteristics are related to the principles of design. To assure clarity, the figures are rendered in several colors and placed opposite the related text. Simple equations reinforce the lucid approach. An ideal textbook or reference on the subject for engineers and advanced technicians. 384 pages; 5 1/2 x 8; illus.; clothbound.

\$7.95 (\$9.55 in Canada)
Circle 12 on Coupon Below

ACOUSTICAL TESTS AND MEASUREMENTS

by Don Davis. Provides a solid understanding of the entire subject of acoustical measurements; based on actual field test work, using commercial equipment. Contains practical, time-saving solutions to actual problems encountered in the field; minimum math is required for understanding. The author is an expert in this field, and an authority on auditorium acoustics. An invaluable book for phone company special service engineers, plant maintenance engineers, communications engineers, noise control specialists, architectural engineers, broadcast engineers and technicians, hi-fi fans and students. 192 pages; 5 1/2 x 8 1/2; hardbound.

\$6.95 (\$8.35 in Canada)
Circle 7 on Coupon Below

Classified

Closing date is the fifteenth of the second month preceding the date of issue. Send copy to:
Classified Ad Dept.

db
THE SOUND ENGINEERING MAGAZINE
980 Old Country Road
Plainview, New York 11803

Rates are 50c a word for commercial advertisements. Non-commercial and employment offered or wanted placements are accepted at 25c per word.

EMPLOYMENT

PROFESSIONAL RECORDING PERSONNEL SPECIALISTS. A selective service for employers and job seekers: engineers, tape editors, production and studio mgrs, traffic assts, etc. Call us today! Smith's Personnel Service, 1457 Broadway, N.Y.C. 10036. Alayne Spertell 212 WI 7-3806.

MANAGER, AUDIO DIVISION. We are seeking an experienced administrator to guide our company's well-established commercial sound product line. The person selected to fill this position will have a broad knowledge of all phases of commercial sound — public address, auditorium sound, school systems, nurses' call and doctors' register, and related fields. At his disposal will be an outstanding engineering staff, ready to accept his direction for product design and development.

This completely autonomous key executive will report to our vice-president marketing. We invite your reply, which will be held in complete confidence. Please contact: C. D. Haverty, (402) 342-2753. McMartin Industries, Inc., 3104 Farnam Street, Omaha, Nebraska 68131.

FOR SALE

SOLID-STATE 50 WATT RMS plug-in d.c. thru 25 kc operational power amplifier kit, model 440K. Price \$30.00. Send for free catalog and 50 operational amplifier applications to: Opamp Labs. 172 So. Alta Vista Blvd., Los Angeles, California 90036.

SOLID STATE VOLUME LEVEL INDICATOR-Daven TR-924C. Accurately measures sound levels for use in broadcasting, soundrecording, etc. Regular price: \$690.00 — Sale Price: \$350.00. Red Arrow Electronic Sales Company, 1215 Summit Avenue, Union, N.J. 07087

BERLANT 20 STEREO RECORDER. Five heads — two erase, two-track record and play, four-track play. Machine is clean, never used for studio operation. Some head wear. Original instructions included. 7 1/2 and 15 in./sec. In original portable cases. Price includes shipment anywhere in continental U.S. Asking \$375. Box C-3, db Magazine, 980 Old Country Road, Plainview, N.Y. 11803

SCULLY TAPE RECORDERS — one to twenty-four track. Two, four, and eight track models in stock for immediate delivery. SCULLY LATHES — Previously owned and rebuilt. Variable or automatic pitch. Complete cutting systems with Westrex heads. MIXING CONSOLES — Custom designed using Wiegand Audio Lab modules. From \$7,000.00. Wiegand Audio Laboratories, 3402 Windsor Road, Wall, New Jersey 07719. Phone: 201 681-6443.

AUDIO EQUIPMENT for churches, schools, recording studios, radio and t.v. stations. New and used. Trade-ins accepted. AMPEX, BOGEN, ELECTRO-VOICE, SHURE, SCULLY, and many others. Free lists. Boynton Studio, 118DB Brook St., Scarsdale, N. Y. 10583.

AMPEX 601 and 400, Magnecord PT-6. G. Shirley, 111 Lake, Tuckahoe, New York 10707.

EDUCATION

EARN YOUR ELECTRONICS ENGINEERING degree, mostly by correspondence. G.I. Bill approved. Credit allowed for previous training and experience. Free Catalog. Write: Dept. E-3, Grantham School of Electronics, 1505 N. Western, Hollywood, California 90027.

SERVICES

WHATEVER YOUR EQUIPMENT NEEDS — new or used — check us first. Trade your used equipment for new. Write for our complete listings. Broadcast Equipment & Supply Co., Box 3141, Bristol, Tenn. 37620.

CUSTOM STYLUS — cartridge re-tipping, re-building, replacements. International Audio Stylus Corp., 111-D Lake Ave., Tuckahoe, New York, 10707 (Telephone: (914) SP9-1297.

DON'T BE AN AUDIO DROPOUT! See BROADCAST EQUIPMENT REBUILDERS for your tape cartridge rewinding needs. Route 8, Box 718, Fayetteville, N.C. 28304. (919) 425-7332.

People, Places, Happenings

CALENDAR OF EVENTS

• April 17th is the date for the **1969 Midwest Acoustics Conference**, the third annual one. It will be held at Northwestern University and the Orrington Hotel, both in Evanston, Illinois (Chicago suburb). According to **Dr. J. Norton Brennan**, this year's chairman, the participating institution will be the University of Wisconsin, which will provide the technical program for the one-day conference. The program is being organized by **Professor Richard A. Greiner** of the Department of Electrical Engineering, University of Wisconsin at Madison. The Midwest Acoustics Conference is held annually to provide a medium whereby midwest universities can report to industry on their work in various fields relating to audio and acoustics.

Mark down **April 28 to May 1** for the **36th Audio Engineering Societies West Coast convention and exhibition**. The place is the Hollywood Roosevelt Hotel in Los Angeles, California. There will be technical sessions galore and an expanded equipment exhibition. Next month we will have a complete detailing of the papers including maps of the exhibition space.

Add to your calendar the dates of **July 14th to the 18th** for the **third annual Brigham Young Audio/Recording Seminar** to be held at the **Brigham Young University** campus in Provo, Utah. There will be lectures, discussions, demonstrations, and an equipment exhibition. Reservations should be made by contacting Dean Vanuiter, 140 Herald R. Clark Building, Brigham Young University, Provo, Utah 84601. Call (801) 374-1211, ext 3761.



• **Charles E. White** has been appointed Editor of **THE EXPERIMENTER** house organ published monthly by **General Radio Company**. Mr. White brings considerable engineering background to his new assignment. His most recent position was with **Avco Corporation** in charge of the test instrument program. He founded and is editor of a newsletter for the National Conference of Standards Laboratories. Recently he has been elected a Fellow of the IEEE.



• **Philips Broadcast Equipment Corporation** has a new president. He is **John S. Auld** who succeeds **Matthew M. Dorenbosch**, who becomes chairman of the board. Mr. Dorenbosch is also executive v-p of North American Philips Company, Inc., the parent company.

Prior to his election, Mr. Auld was vice-president and general-manager of Philips broadcast. Before joining the company in 1966 he had been associated with **Fairchild Camera and Instrument Corporation** where he was first director of marketing for the space and defense division, and then general manager of the **DuMont Laboratories** division.

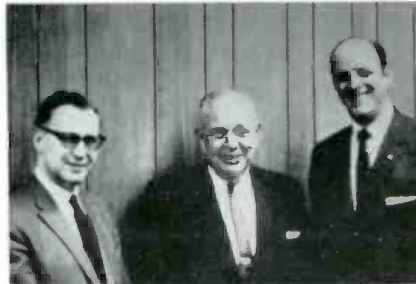

• **Horace L. White**, v-p industrial and governmental sales for **Jensen Manufacturing Division**, The Muter Company, recently observed his 40th year of service with the company. The illustration shows Mr. White (center) being presented with a memento of the occasion by (left) **E. G. Van Deveer**, v-p marketing, and **Herbert J. Rowe** (right) chairman of the board of The Muter Company.

It is with sadness that we report the death of **William F. Endres**, age 63, after a long illness. Mr. Endres was traffic manager for Fairchild Recording Equipment Corporation and as such was well known to Fairchild's customers. He was associated with the company for over sixteen years, first as manager, sub-contracts division and then as traffic manager. He leaves a wife, two sons, a daughter, and several grandchildren.

Superscope Back Cover Circle 12 on Reader Service Card →

**this
rek-o-kut
b-12 gh
turntable
is basically
unchanged for
nearly 10 years**



**and it works, and
works, and works and
works and works.....**

Take a look through control and audition rooms of the stations in your community and count the number of Rek-O-Kut turntables that keep going and going and going. Minimum maintenance, practically no repair. Faithful, reliable sound. Year after year after year. Ask those station engineers how long they've had Rek-O-Kut installed. You'll find some of those turntables have been around a long time.

Rek-O-Kut turntables are built to take it. They are simple in design and operation, strong in construction. If you have a Rek-O-Kut now, we'd hardly be able to sell you a replacement. But we'd like to sell you another!

specifications:

SPEEDS: 33 $\frac{1}{3}$, 45, 78 rpm. NOISE LEVEL: -59db below 5 cm/sec average recorded level. MOTOR: custom-built computer type heavy-duty hysteresis synchronous motor. 45 RPM HUB: instantaneously removable by hand. PILOT LIGHT: neon light acts as an "on/off" indicator. FINISH: grey and aluminum. DECK DIMENSIONS: 14 x 15 $\frac{1}{4}$ ". Minimum Dimensions: (for cabinet installation) 17 $\frac{3}{4}$ " w. x 16" d. x 3" above deck x 6 $\frac{1}{4}$ " below. PRICE: B-12 GH Turntable \$124.95. S-320 Tonearm \$44.95. Optional BH Base for audition room \$18.95.

rek-o-kut turntables by



KOSS

KOSS ELECTRONICS INC.
2227 N. 31st Street • Milwaukee, Wis. 53208

Export: Koss Electronics S.r.l.
Via Bellini 7, 20054/Nova Milanese, Italia

Export Cable: Stereofone



Circle 11 on Reader Service Card

Stereo on location: Only 24 lbs. 11 oz.

Better-than-Studio Specs. Frequency response: 20 Hz to 22 KHz, 40 Hz to 18 KHz ± 2 db @ $7\frac{1}{2}$ ips. S-N ratio at peak level to unweighted noise: (Model 770-2) 58 db or better; (Model 770-4) 56 db or better. Wow and flutter: less than 0.09% @ $7\frac{1}{2}$, less than 0.12% @ $3\frac{3}{4}$, less than 0.2% @ $1\frac{1}{8}$. Full 7-inch reel capacity.

Four Heads. The 770-2 has two-track erase, record, and playback heads plus a four-track playback head. The 770-4 has four-track erase, record, and playback heads plus a two-track playback head.

Lightweight. A studio professional tape deck you can pick up and take anywhere or use in your studio. Operates on a self-enclosed rechargeable nickel-cadmium battery pack—or plugged into AC.

ServoControl Motor with Vari-Speed Tuning. Automatically maintains exact speed during mechanical load changes and voltage variations. Built-in Vari-Speed tuning for vernier adjustment of playback speeds to match musical pitch.

Exclusive Sony Noise-Reduction System. Sony "SNR" automatically reduces gain of playback amplifier by 6 db during very low passages, when background noise is most predominant. Noise level is greatly reduced, dynamic range expanded 100%. Switch permits bypassing "SNR" when desired! Sony also incorporates automatic built-in limiter to control top-end overload distortion. Built-in defeat switch.

Three Speeds. $7\frac{1}{2}$, $3\frac{3}{4}$, $1\frac{1}{8}$ ips. Other features include two professionally-calibrated VU meters, built-in line-and-mike mixing, push-button operation, scrape flutter filter, low-impedance Cannon plug mike inputs, tape/source monitoring.

Sony Model 770. Priced at \$750. For a free copy of our latest tape recorder catalog, write to Mr. Phillips, Sony/Superscope, Inc., 8207 Vineland Avenue, Sun Valley, California 91352.

SONY SUPERSCOPE The Name in Stereo

You never heard it so good.